

BillyOh 8ft Gable  
Keeper Overlap  
Apex Range<sup>®</sup>  
Windowed / Windowless  
Technical Details



For Queries and Help  
please call Product  
Support:  
01636 858377

# 8ft Gable Windowed/Windowless Overlap Shed (Double Door Range)

Front elevation: width 2.598m/8' 6"

## Sizes available

available in standard 7mm cladding types

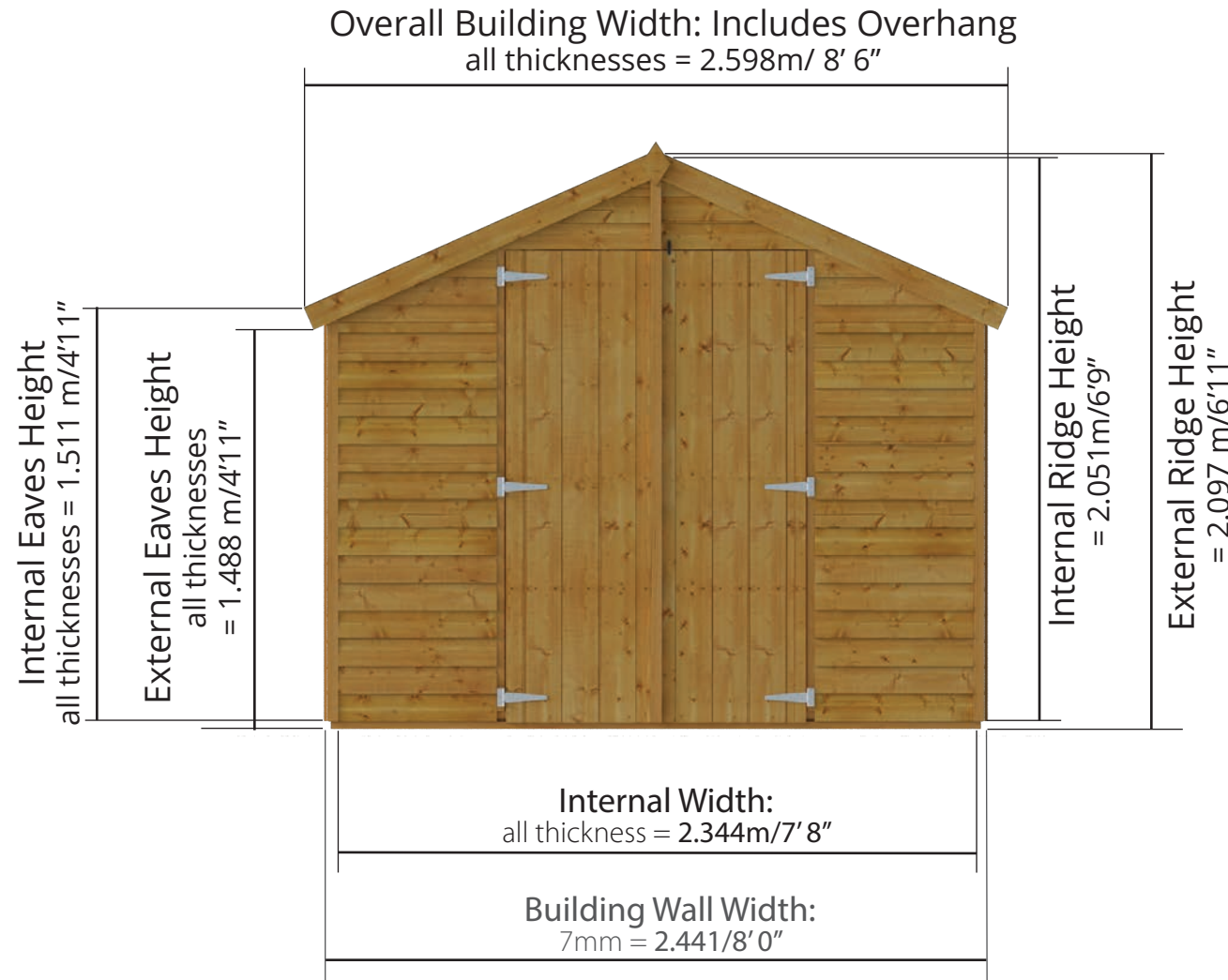

Windowed / Windowless  
D12ft x W8ft  
(Including Overhang)



Windowed / Windowless  
D16ft x W8ft  
(Including Overhang)



Windowed / Windowless  
D8ft x W8ft  
(Including Overhang)



Windowed / Windowless  
D10ft x W8ft  
(Including Overhang)



Windowed / Windowless  
D4ft x W8ft  
(Including Overhang)



# D4.754m x W2.598m / D16' 7" x W8' 6"

## Windowed Overlap Apex Shed:

### Side elevation

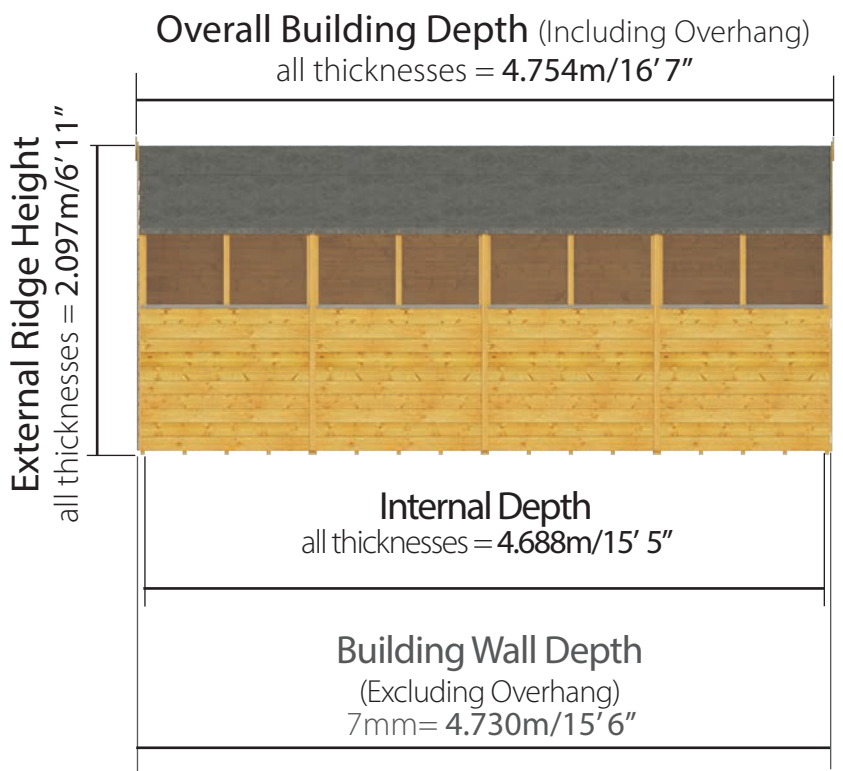

Side of Building

### Floor Plan

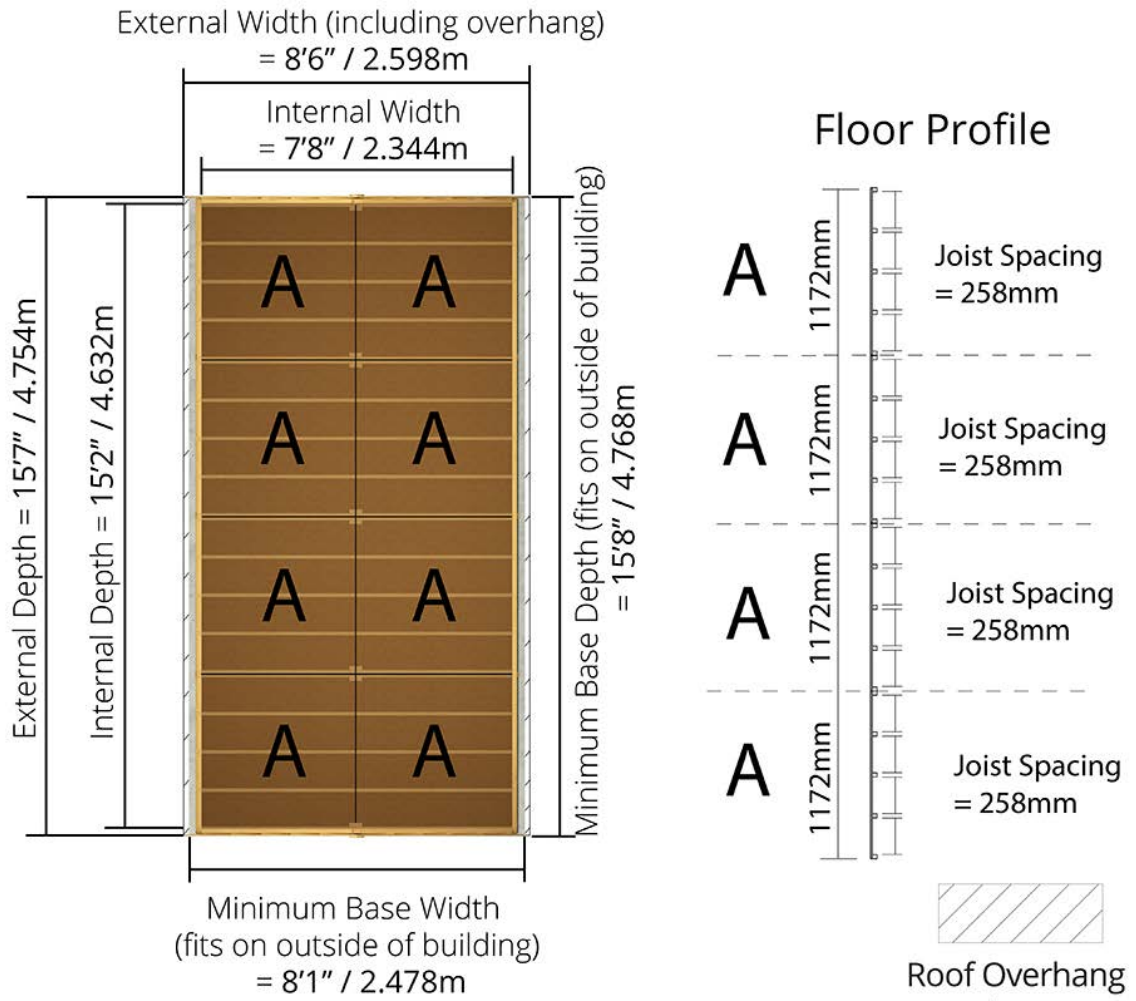

Front of Building

Please note: your base must be perfectly level and drainage is required to allow water to run off the surface. There must also be at least 2m clearance on each side to allow annual treatment to be applied.

# D4.754m x W2.598m / D16' 7" x W8' 6"

## Windowless Overlap Apex Shed:

### Side elevation

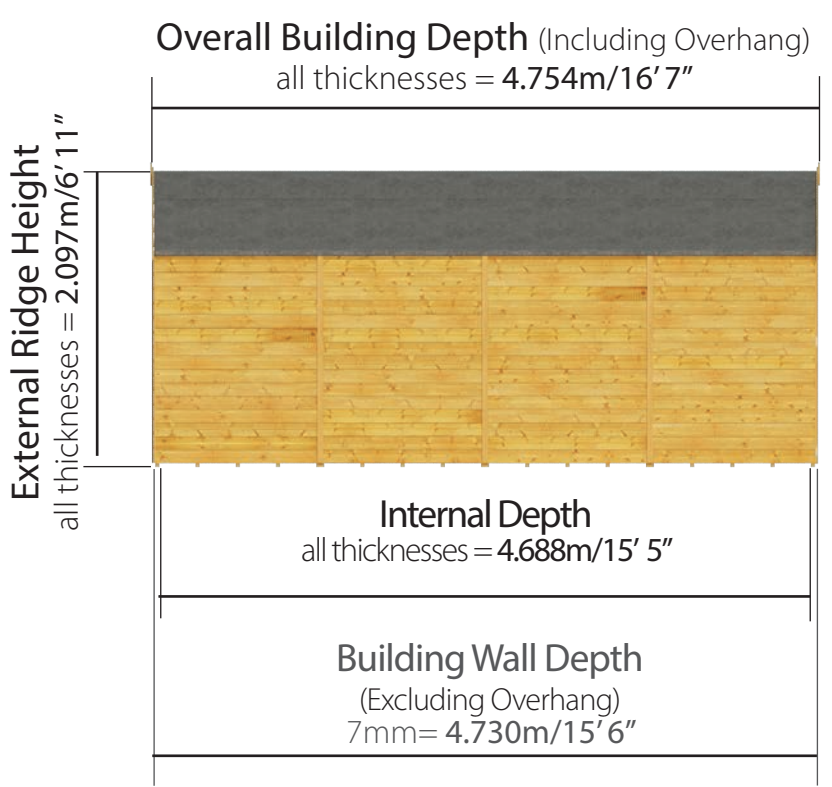

Side of Building

### Floor Plan

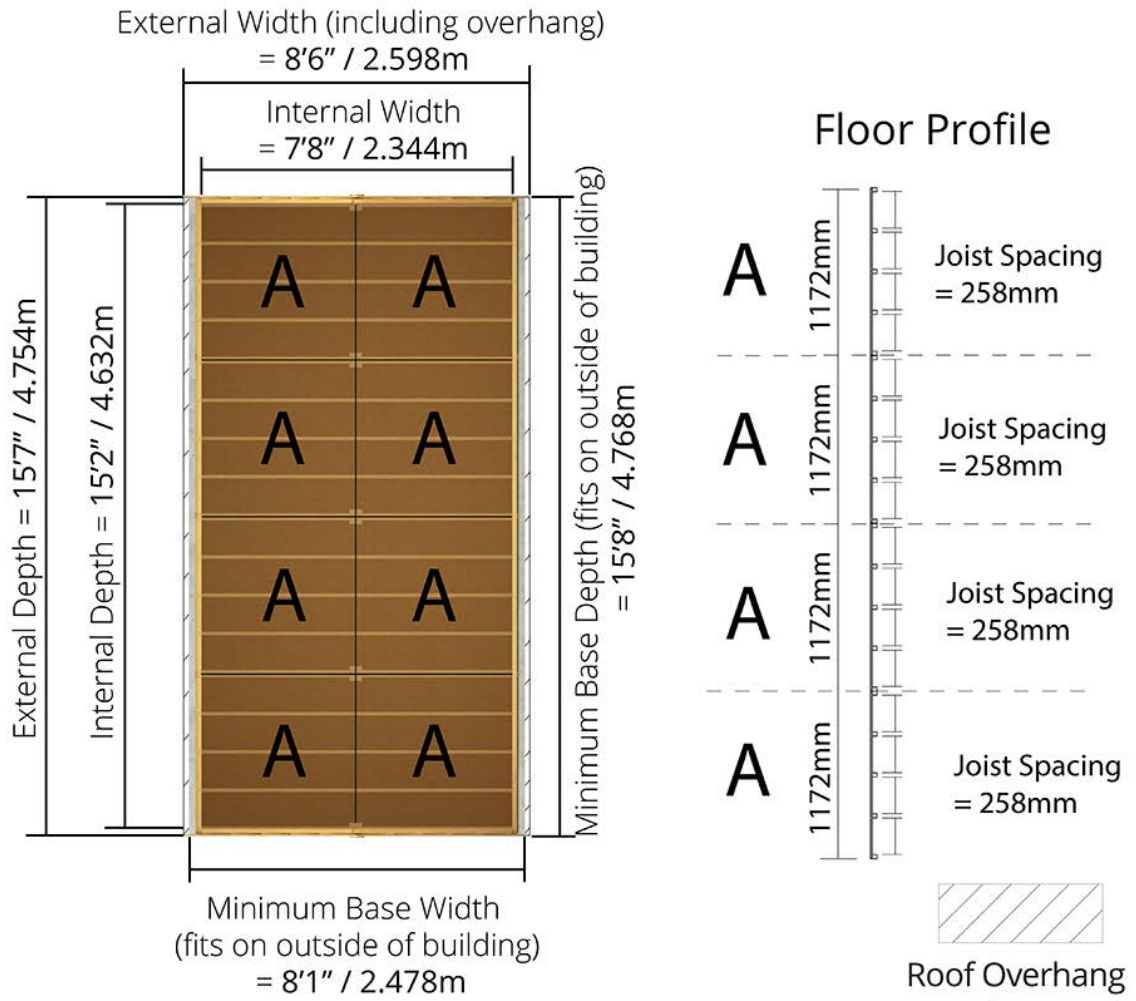

Front of Building

Please note: your base must be perfectly level and drainage is required to allow water to run off the surface. There must also be at least 2m clearance on each side to allow annual treatment to be applied.

D4.754m x W2.598m / D11' 9" x W8' 6"

# Windowed Overlap Apex Shed:

## Side elevation

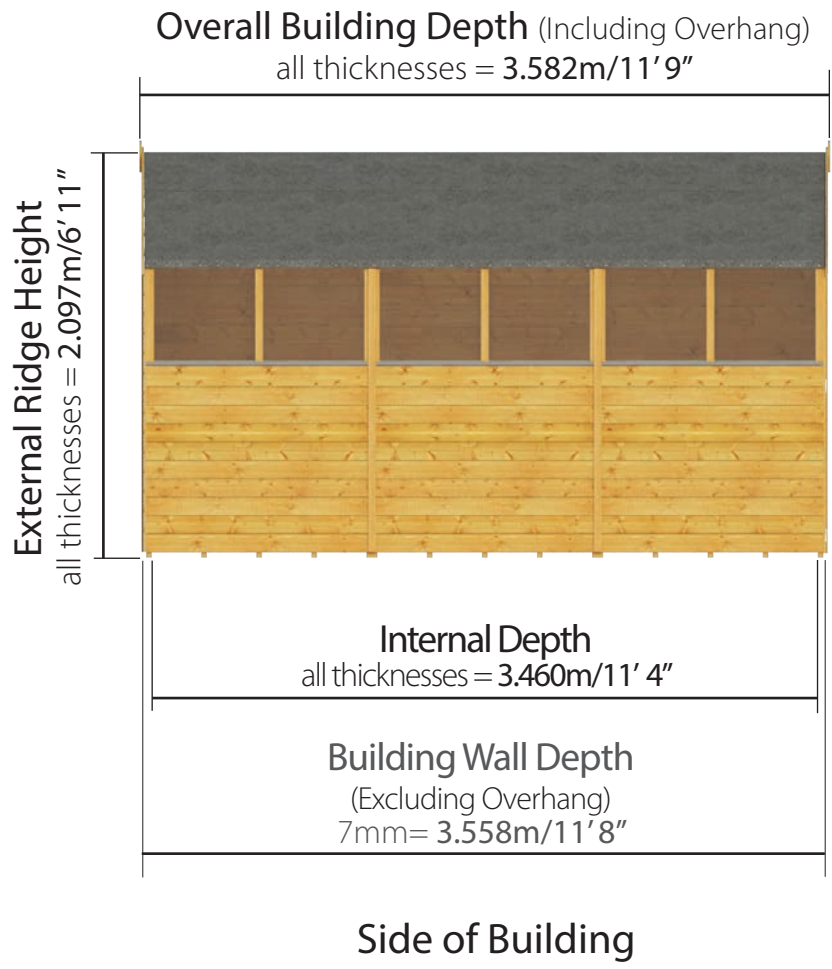

## Floor Plan

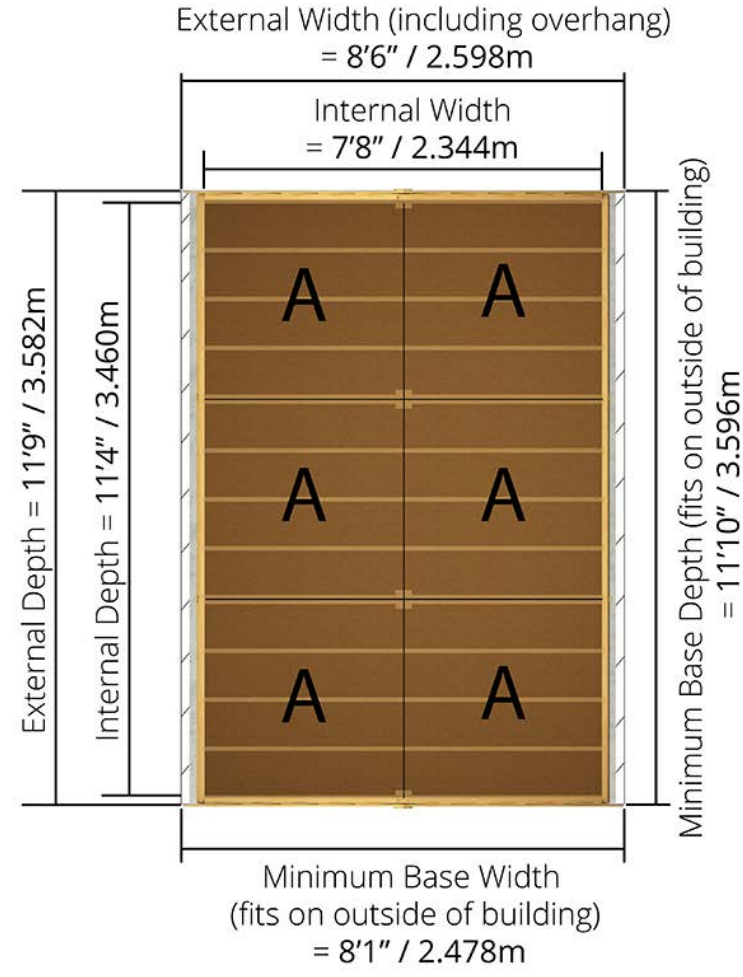

## Floor Profile

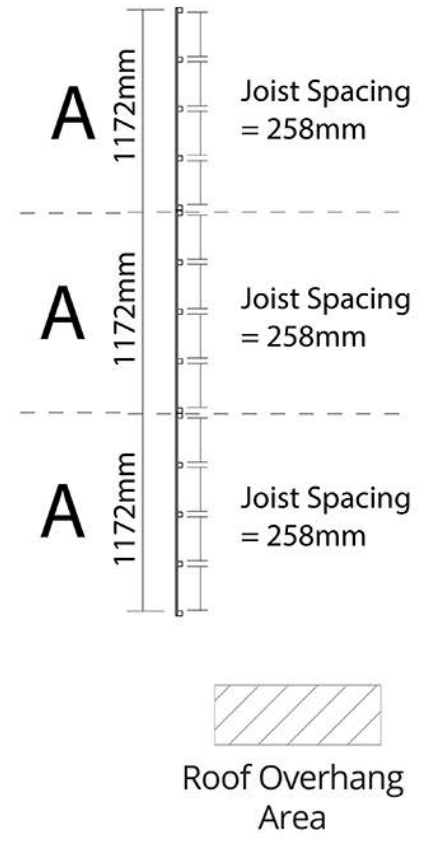

Please note: your base must be perfectly level and drainage is required to allow water to run off the surface. There must also be at least 2m clearance on each side to allow annual treatment to be applied.

# D4.754m x W2.598m / D11' 9" x W8' 6"

## Windowless Overlap Apex Shed:

### Side elevation

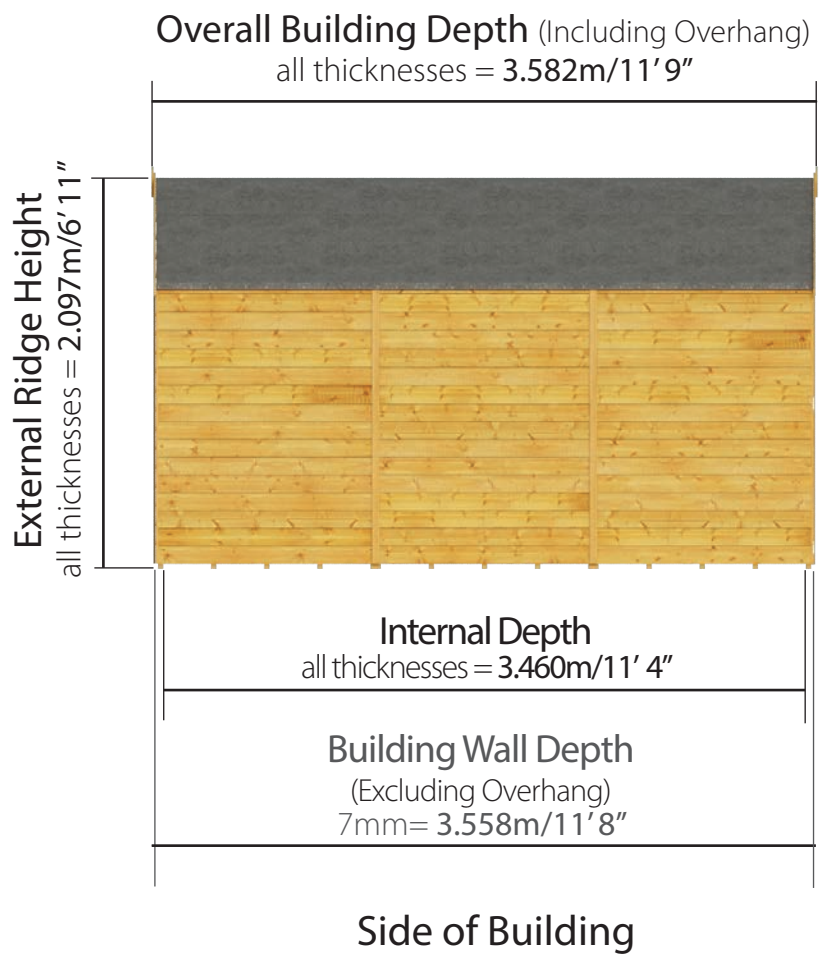

### Floor Plan

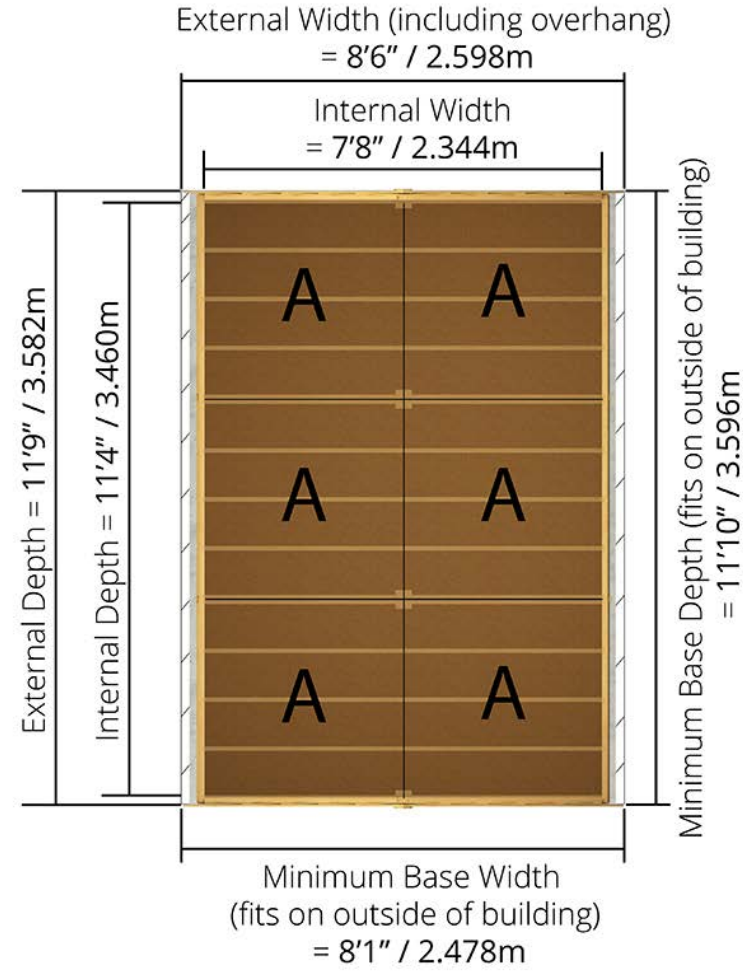

### Floor Profile

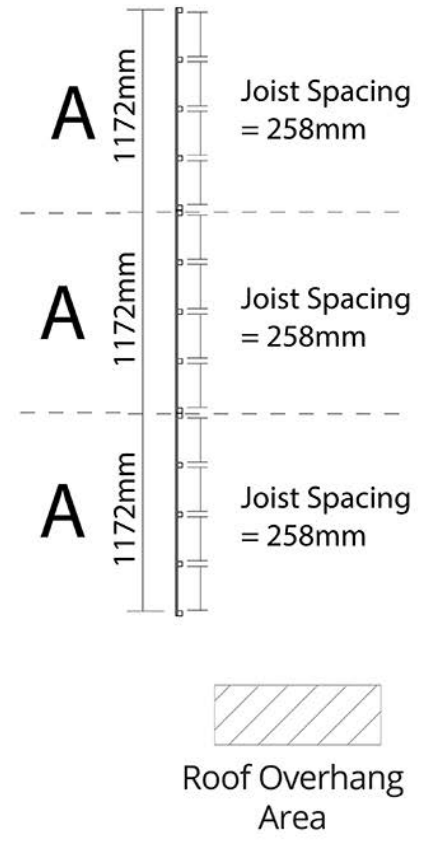

Please note: your base must be perfectly level and drainage is required to allow water to run off the surface. There must also be at least 2m clearance on each side to allow annual treatment to be applied.

D2.996m x W2.598m / D9' 10" x W8' 6"

# Windowed Overlap Apex Shed:

## Side elevation

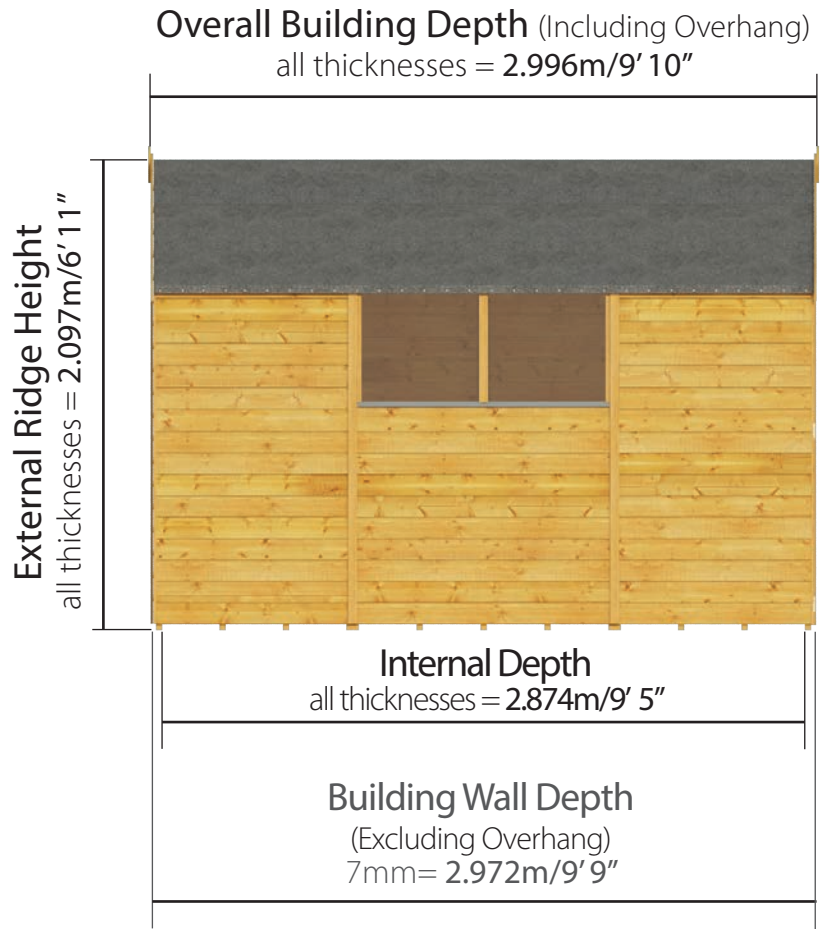

Side of Building

## Floor Plan

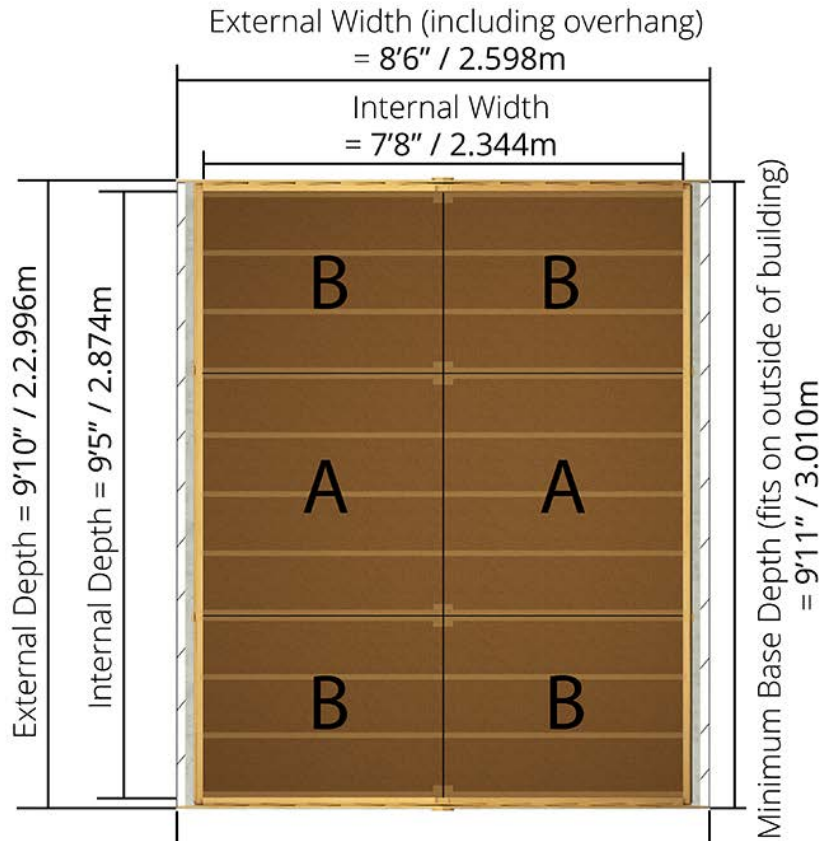

Front of Building

## Floor Profile

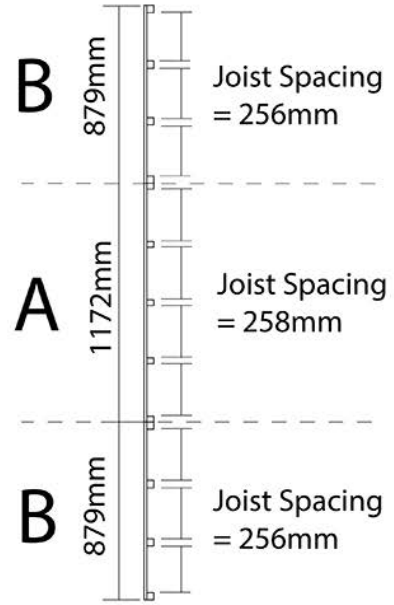

Roof Overhang Area

Please note: your base must be perfectly level and drainage is required to allow water to run off the surface. There must also be at least 2m clearance on each side to allow annual treatment to be applied.

# D2.996m x W2.598m / D9' 10" x W8' 6"

## Windowless Overlap Apex Shed:

### Side elevation

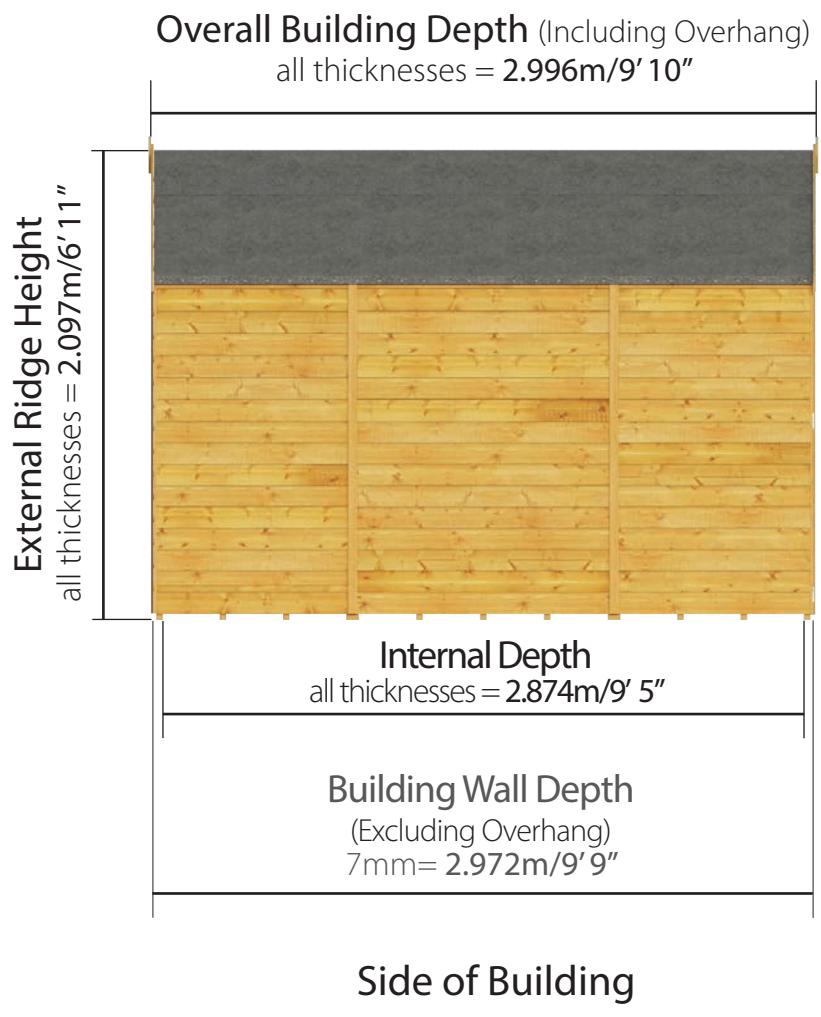

### Floor Plan

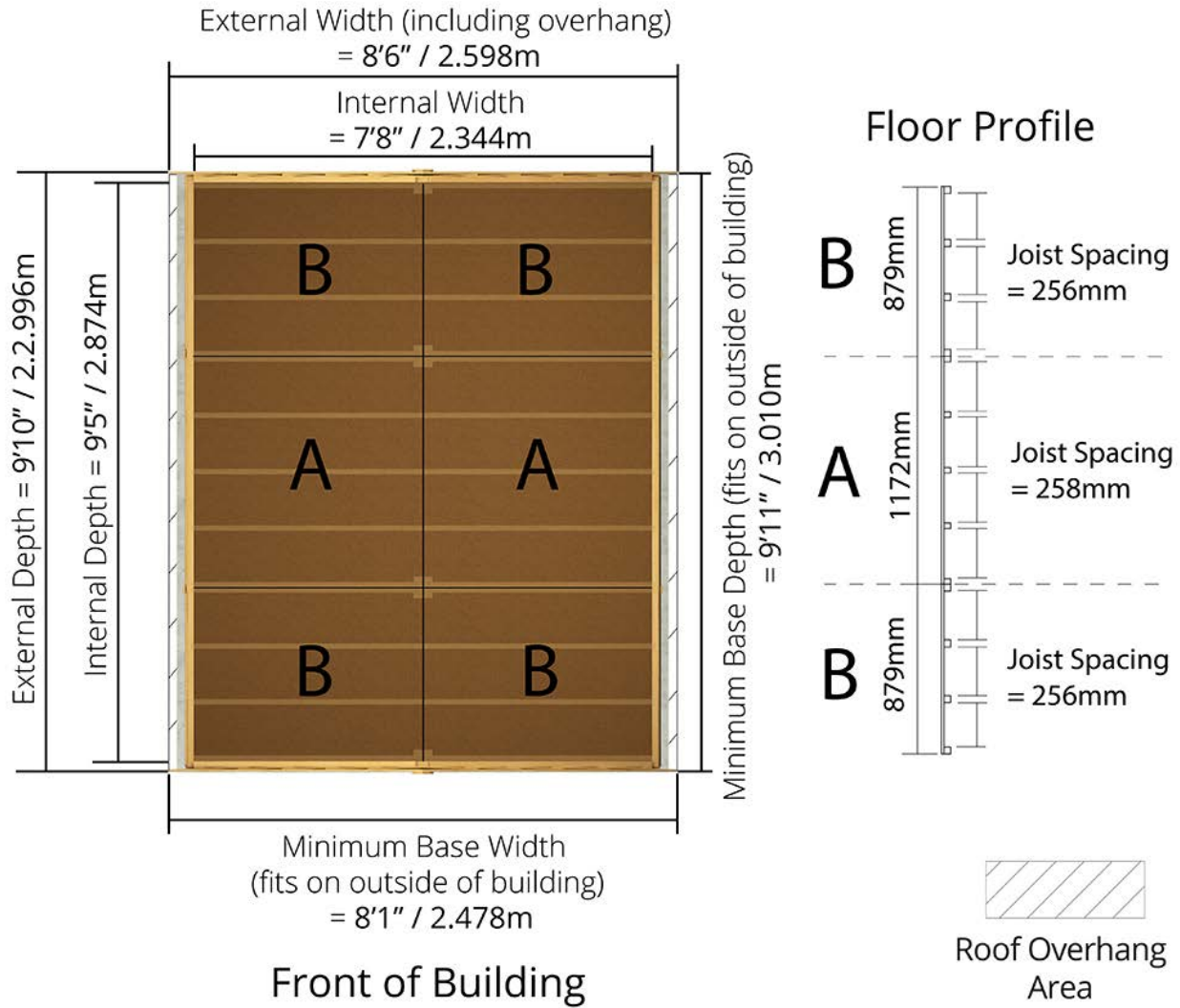

Please note: your base must be perfectly level and drainage is required to allow water to run off the surface. There must also be at least 2m clearance on each side to allow annual treatment to be applied.



# D2.410m x W2.598m / D7' 11" x W8' 6"

## Windowed Overlap Apex Shed:

### Side elevation

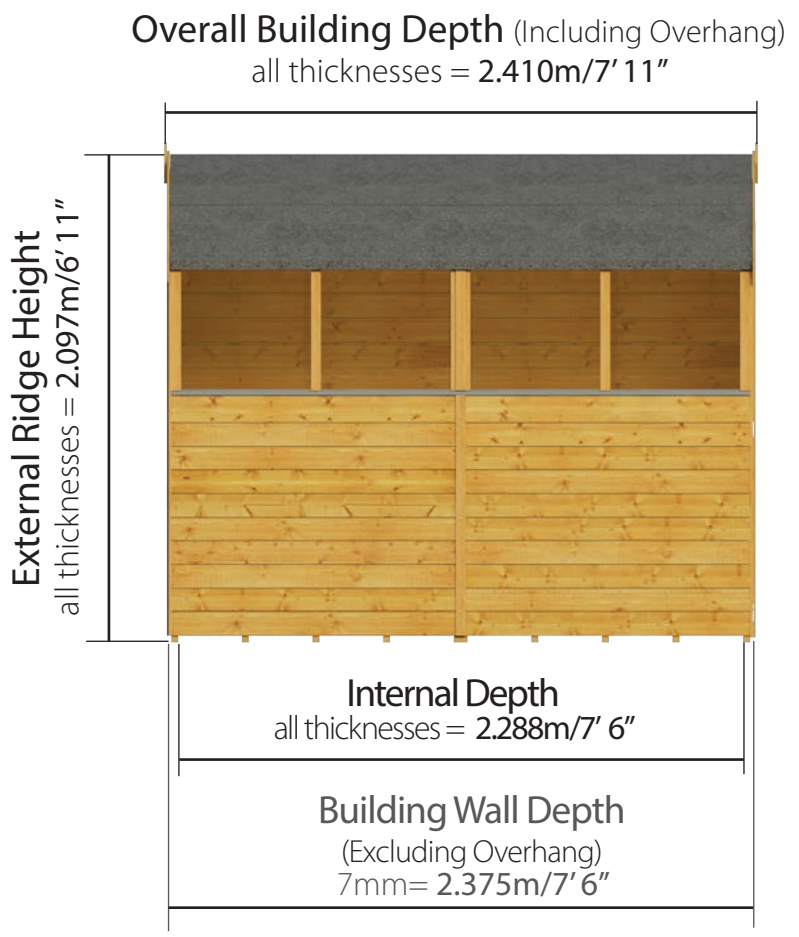

Side of Building

### Floor Plan

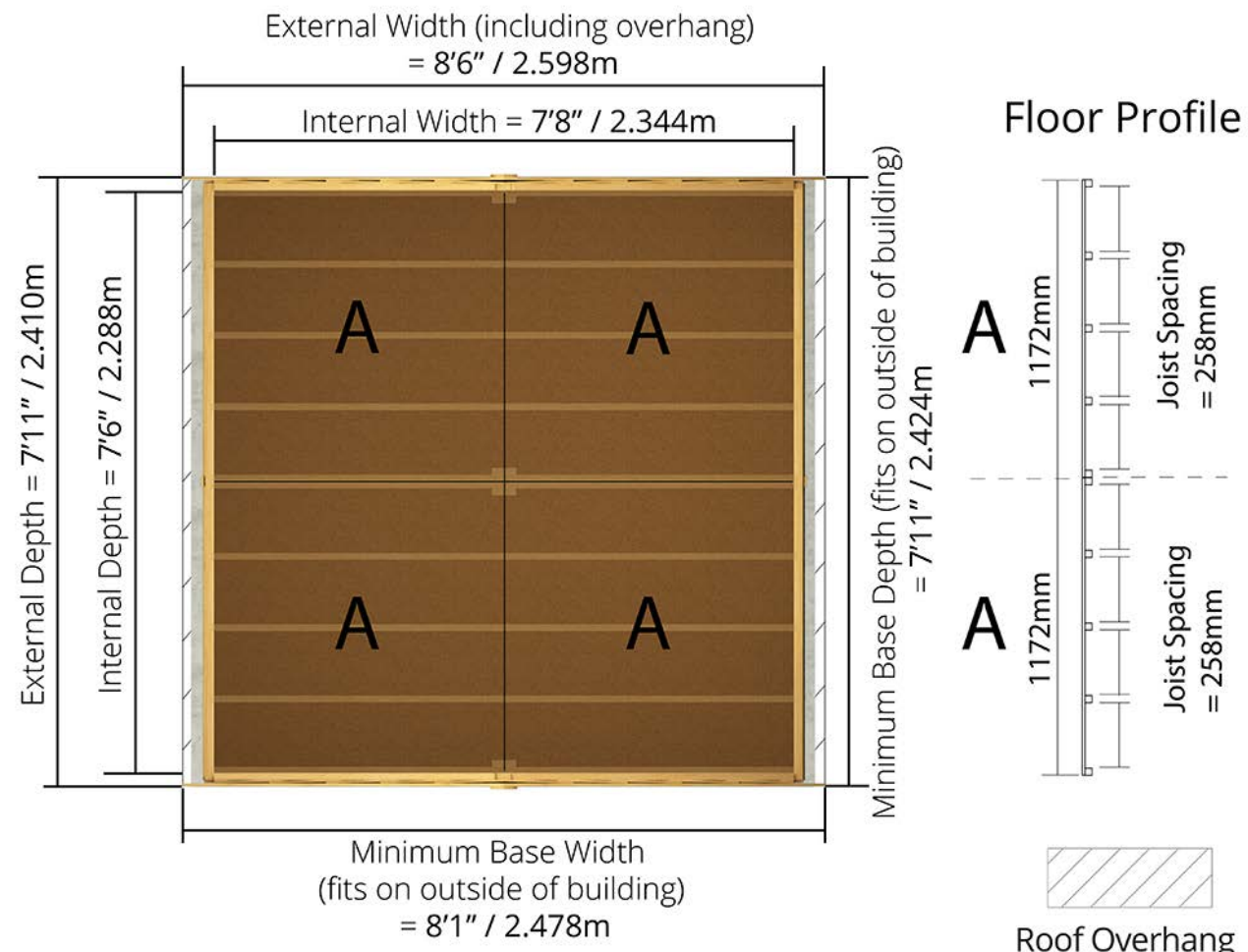

Front of Building

Please note: your base must be perfectly level and drainage is required to allow water to run off the surface. There must also be at least 2m clearance on each side to allow annual treatment to be applied.

# D2.410m x W2.598m / D7' 11" x W8' 6"

## Windowless Overlap Apex Shed:

### Side elevation

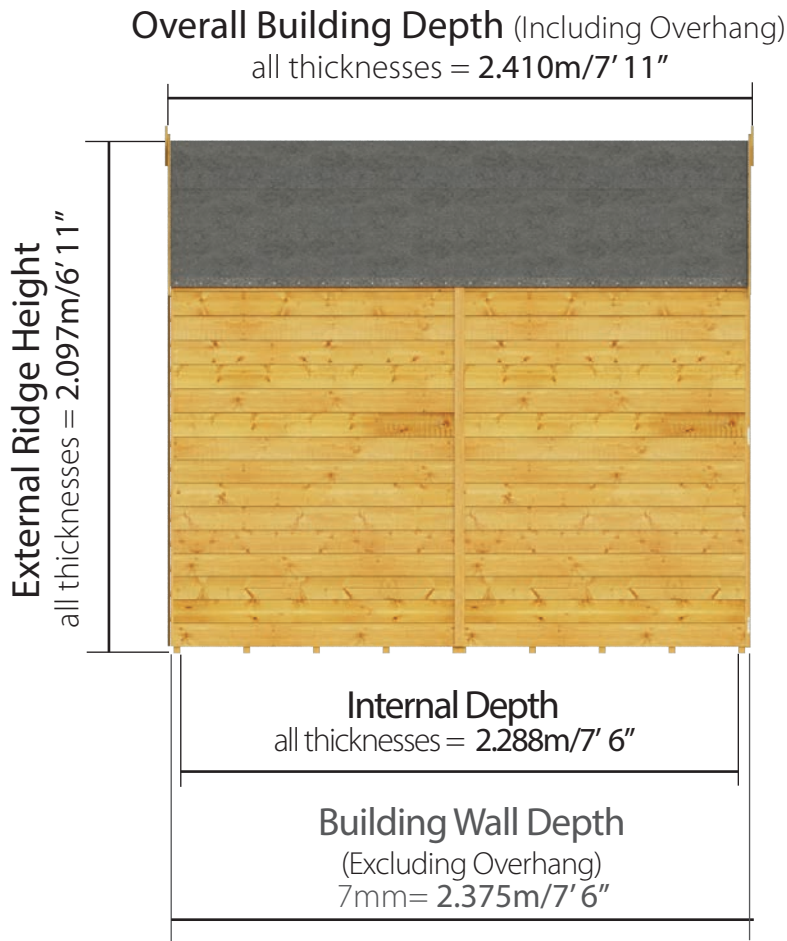

Side of Building

### Floor Plan

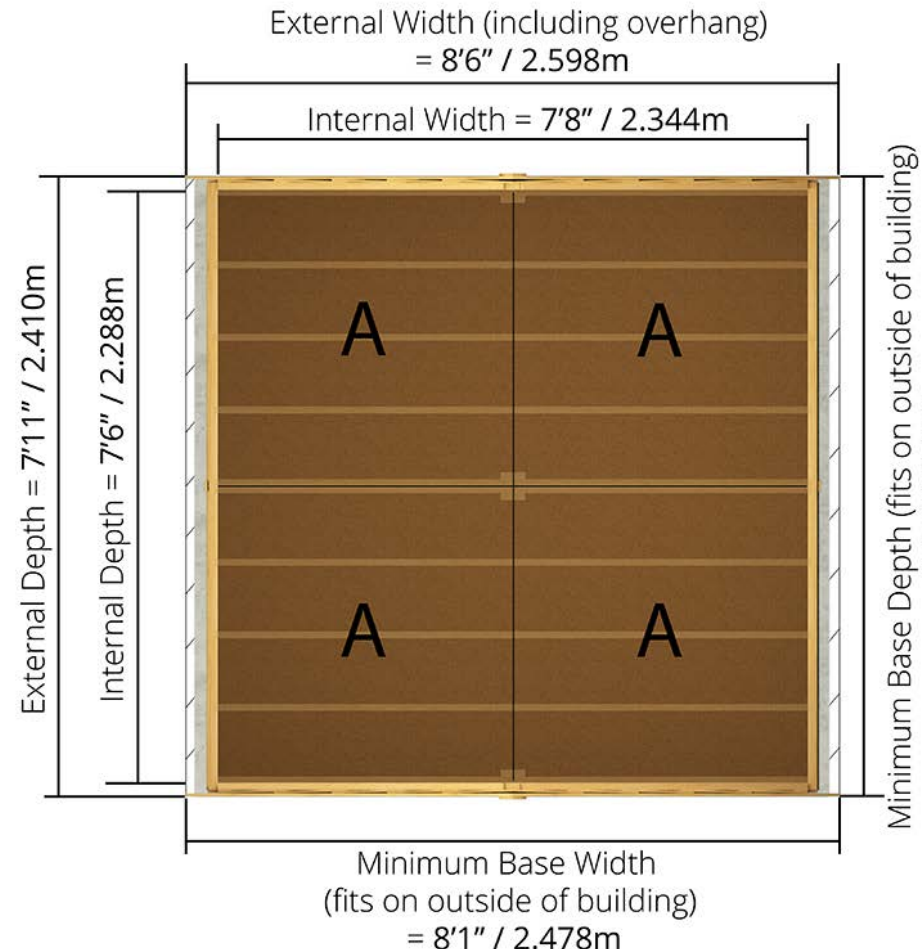

Front of Building

### Floor Profile

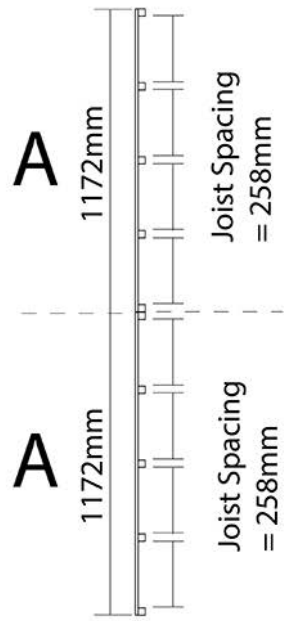

Please note: your base must be perfectly level and drainage is required to allow water to run off the surface. There must also be at least 2m clearance on each side to allow annual treatment to be applied.

D1.238m x W2.598m / D4' 1" x W8' 6"

# Windowed Overlap Apex Shed:

## Side elevation

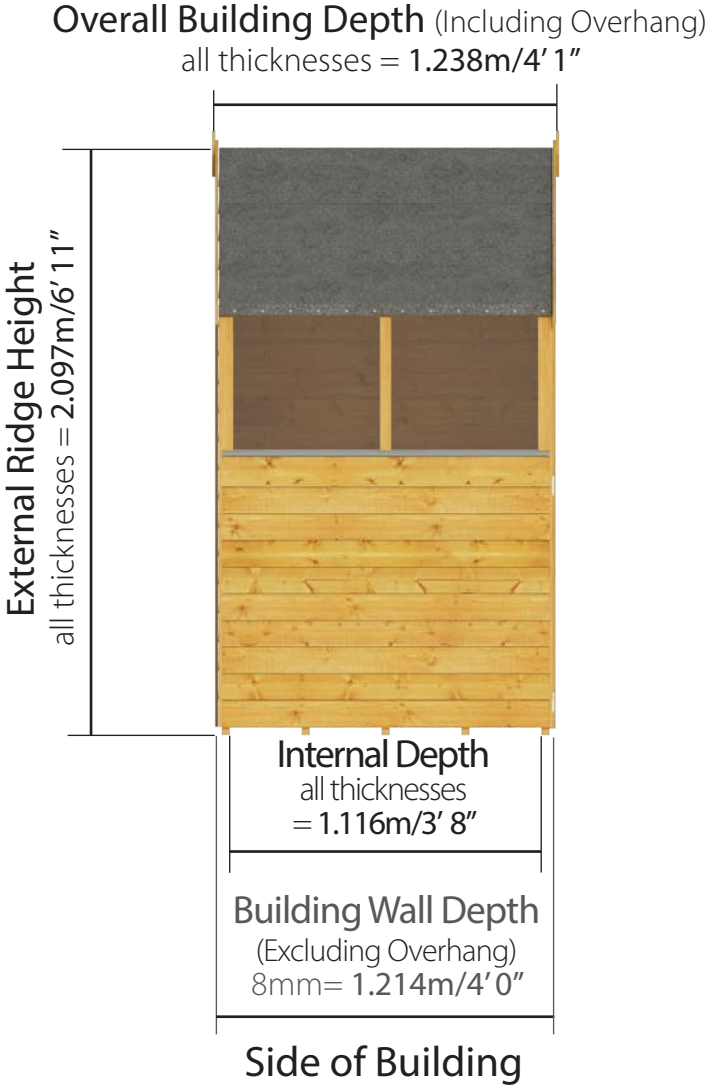

## Floor Plan

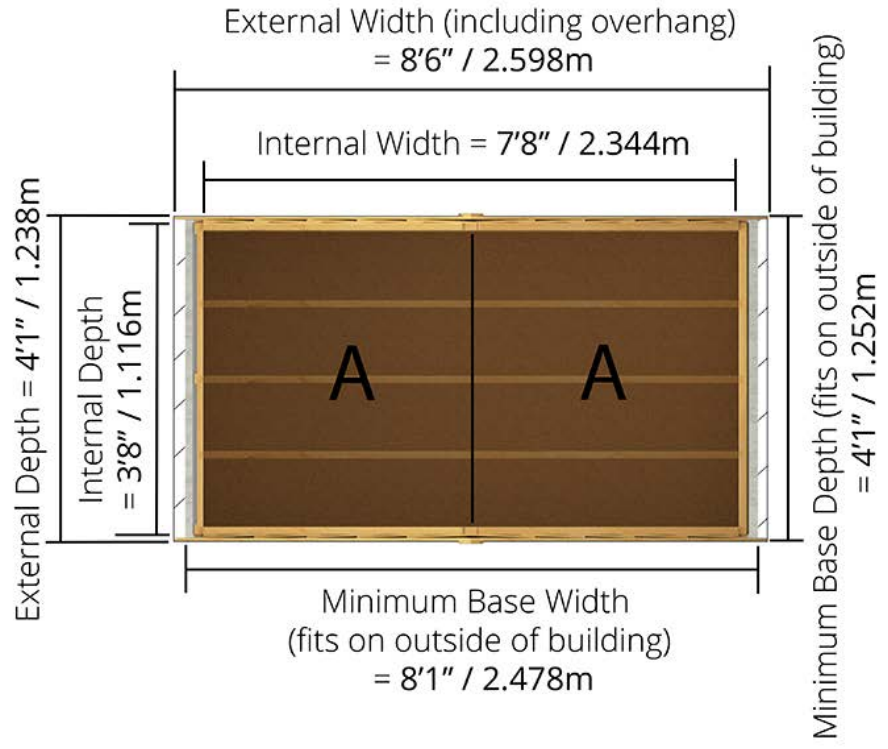

## Floor Profile

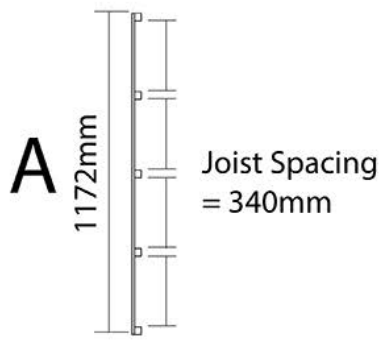

Roof Overhang Area

Please note: your base must be perfectly level and drainage is required to allow water to run off the surface. There must also be at least 2m clearance on each side to allow annual treatment to be applied.

# D1.238m x W2.598m / D4' 1" x W8' 6"

## Windowless Overlap Apex Shed:

### Side elevation

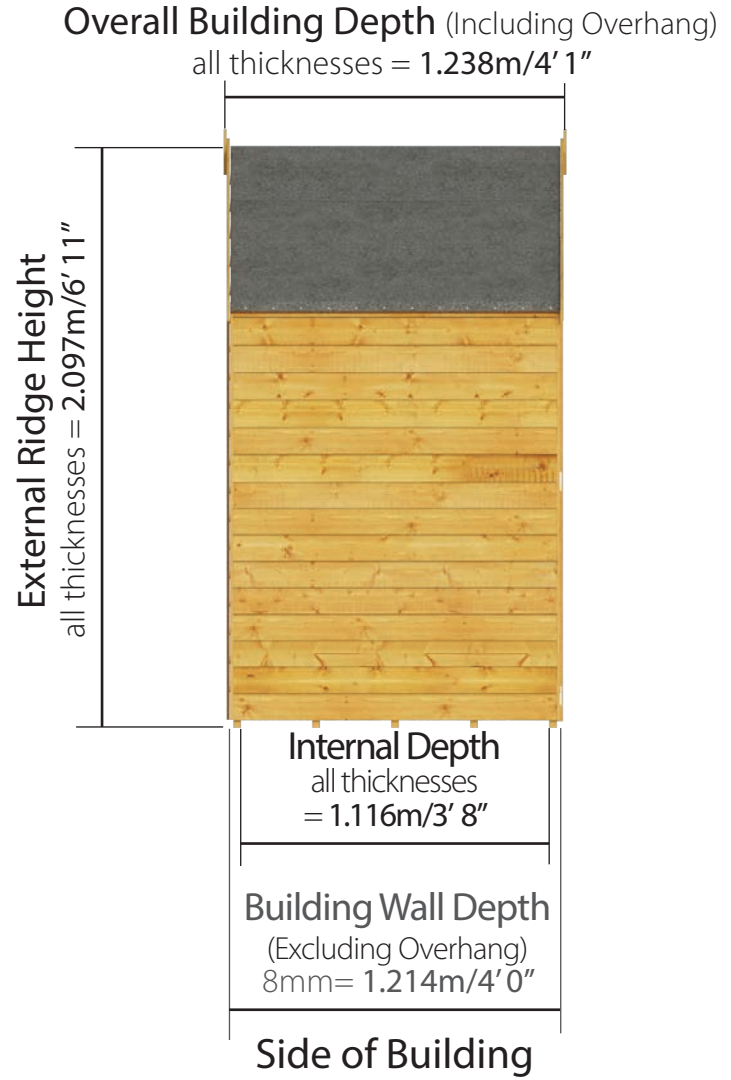

### Floor Plan

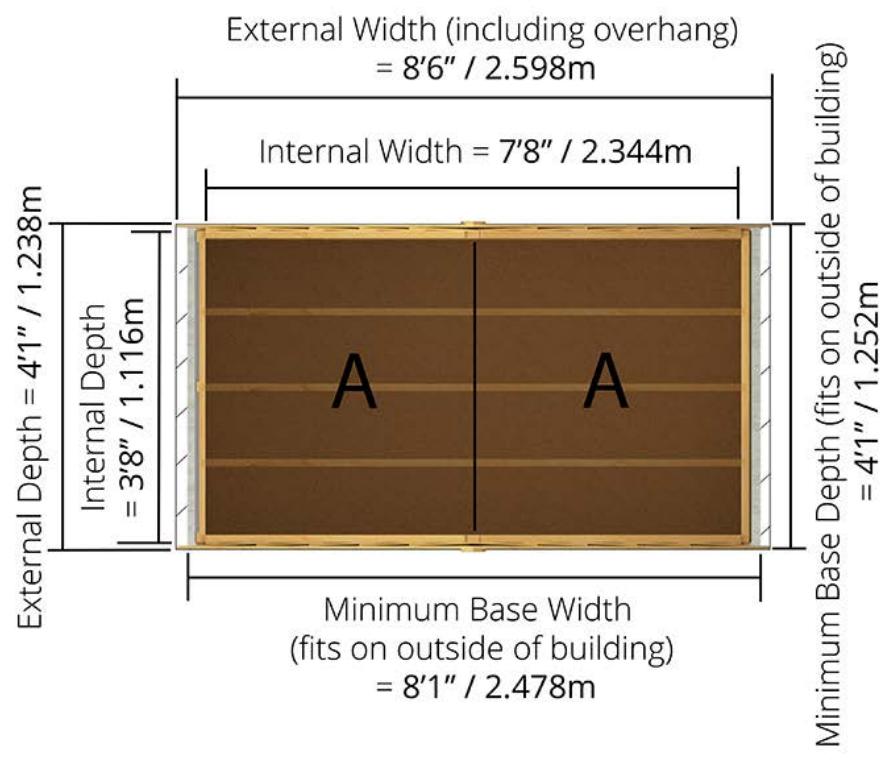

### Floor Profile

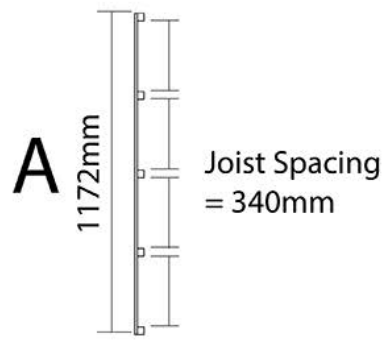

Please note: your base must be perfectly level and drainage is required to allow water to run off the surface. There must also be at least 2m clearance on each side to allow annual treatment to be applied.