

8ft Gable Double Door Building Instructions

Please print and read the instructions carefully
and please retain for future reference

BILLYOH

Creating a garden lifestyle...

Please note that all images are for illustration purposes only.

For Queries and Help please contact Product Support: 01636 858 377



RANGES COVERED: 20, 30

Covers Multiple Sizes:
3x8, 4x8
6x8, 8x8
10x8, 12x8



Covers Windowed Double Door
All 8ft Gable Sizes



Covers Windowless Double Door
All 8ft Gable Sizes



Cover Windowed Double Door
All 8ft Gable Sizes



Covers Windowless Double Door
All 8ft Gable Sizes

**BEFORE
YOU
START**

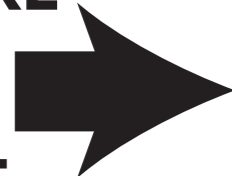

1) Take 5 minutes and have a coffee.



2) Reacquaint yourself with the parts, QTY's and Sizes on the PACKING LIST.



3) Read the instructions thoroughly and then re-read if necessary.

CODE:

INS-0006

IMPORTANT SAFETY NOTICES

GARDEN BUILDINGS: THESE PRODUCTS ARE INTENDED FOR DOMESTIC AND OUTDOOR USE ONLY.
These products have been designed as an affordable solution to most popular light domestic uses.

ALWAYS BE ON THE SAFE SIDE – IMPORTANT SAFETY TIPS

- This building should be constructed by at least two adults.
- Do not use this product if it has been modified or damaged.
- Allow adequate time to complete construction. If you hit any snags, take a break, keep calm, and seek additional help if necessary.
- Make sure that there is adequate space around the construction site to enable access to all sides of the building during construction.
- Do not attempt to construct the building in strong winds or poor weather conditions.
- Make sure that any ladders used during construction are in a good condition and that all tools are in good working order.
- The building is not completely stable until construction is complete and the roof of this building is not intended to support significant weight. **Do not climb on the roof.**
- Keep bags, nails and fixings out of the reach of children.

Due to the nature of wooden panel products please watch out for the following minor blemishes:

- Protruding nails = hammer in the nails so that they are flush with the wood's surface.
- Splintered wood = smooth down with sandpaper.
- Loose or dead knots = use a non-toxic wood glue to secure.
- Wear protective gloves and robust clothes during construction.
- Make sure that any paint or preservative that you use is non-toxic and complies with EN71 regulations.
- Perform periodical checks throughout the life of the building to ensure that the original condition is maintained.
- Construct your building within a month of delivery to reduce the chances of the panels / boards warping.

AFTER MARKET MODIFICATION

- We do not recommend modifying this product. However, customers do enjoy modifying their buildings with their own specific needs in mind as our products allow for a wide range of uses.
- If you modify this product for your own personal requirements you are doing so at your own risk.
- Customers who modify their buildings should make sure to do so safely and so that they do not affect the integrity of the structure.
- If you are thinking of modifying this building be aware that any modifications invalidate your warranty and may affect your consumer rights.

MAINTENANCE

- If there is any cause for concern or any other problems are found on or after delivery, such as damaged parts **DO NOT BUILD**, please visit our Support Centre - www.gardenbuildingsdirect.co.uk/help for further advice and resolution and stop all use before assembly until issues are resolved.
- **IMPORTANT:** Throughout the life of the building please conduct checks to ensure the original condition is maintained.

PRODUCT WARRANTY

- Products are built to the highest quality standards and should provide convenient, secure storage for years to come, this of course being subject to reasonable use, care and transportation.
- If in doubt about the product's limitations please read and understand all of the instructions and guidance notes. If necessary please contact the retailer that the item was purchased from.
- Please contact the retailer from which the product was purchased for warranty and guarantee information.
- PLEASE NOTE: The warranty does not extend to damage caused by post-purchase transportation, careless handling or damage caused by misuse or modification.
- Treat your building annually with a quality timber treatment to comply with the buildings warranty.

SPARE PARTS

- If you ever need to purchase spare parts for your building you can do so by contacting customer services by calling our Product Support - 01636 858 377 where our friendly team will help you buy what you need.

GENERAL RECOMMENDATIONS

Thank you for purchasing this building. We hope you will be delighted with your new building for many years to come. These instructions have been written as a guide to assembling this building and will provide you with an overview of the process of constructing this building. There are a number of considerations to be thought of before constructing the building and how to maintain your building upon completion. This section is also aimed at ensuring you are aware of considerations such as: location for construction, treatment of the building and construction information.

GLAZING: The glazing is generally bound with a holding band and may look like one thick piece when delivered. It may even be in between two of the panels as might the fixing kit. **REMOVE PROTECTIVE FILM FROM ALL GLAZING BEFORE USE.** The glazing is safer to use than glass and is an economic solution for garden building use, but must be installed correctly, carefully and safely. Glazing that is fitted to the outside of buildings is an uncomplicated method that does not require beading. The glazing on all the garden buildings does not make the windows water tight and we suggest using a silicon sealant to improve water resistance around the edges of the glazing.

DOORS: Generally the doors are sent loose for all buildings. Some buildings such as summerhouses may have the doors already fixed to the door frame. If your building is not built on a flat, level surface you may experience difficulties when fitting your doors. You may find a gap between the doors or around the edges.

This is not a fault as the doors will move, shrink and expand during different weather conditions. Occasionally during transit the door frame can become misaligned. This is easily solved by hanging the door on a level surface **BEFORE** the panels are attached. **SUMMERHOUSES:** Some summerhouse doors are held together at the base of the frame with a screw or nail for transportation purposes. Remove this screw or nail before commencing construction.

PANELS: The panels that of your building may move during transit resulting in them becoming un-square. Simply tap the panel at it's corners and make sure that the measurements from top to bottom diagonally across the panel is equal. This should make the panel square

BUILDING LOCATION & CONSTRUCTION: Locate your building in a suitable and well prepared area, which is flat and protects the building as much as possible from extreme weather conditions such as high wind, snowfall, flooding etc. **It is very important that a solid and level foundation is prepared to ensure the building will be level and square.** This will help ensure that all parts fit correctly. The building is not fully structurally sound until construction is complete. You may experience moments, such as when building the wall panels, where you feel the building is not safe and may be flexing too much. This is perfectly natural so do not worry and take your time as full rigidity for the building will only occur on completion of the construction process. **We recommend that you construct your building within 1 month of delivery as the timber may begin to warp.**

TREATMENT: Treating the product when assembled is essential to ensure the building will not deteriorate. We recommend you apply the finishing product to a small area to ensure it provides the intended result before proceeding.

IMPORTANT NOTICE: The natural moisture content of wood will change according to season. We recommend applying a quality timber treatment to minimise the effects. Re-apply treatment annually to prolong the building's life.

WOOD CHARACTERISTICS: Wood is a natural material, which means that no two boards on your building will be identical and will expand and contract due to moisture levels. This natural affect of expansion and contraction is inevitable and is compensated for by the tongue and groove construction in tongue and groove buildings. The timber in overlap buildings may warp and twist over time, which is a natural process. The timber may crack naturally over time, but will not affect the structural integrity of the building provided it has been assembled as advised. Keep panels away from trees, fences and other high moisture containing elements to reduce and help prevent warping. If boards warp and twist it is possible to purchase replacement boards to do so call our Product Support on 01636 858377. Keep your building ventilated to avoid mould.

This building is water resistant, but not water tight. Please wait for weather to change before notifying us if you notice changes in the structure.

TOOLS REQUIRED: - Drill with 4.5, 3 and 2mm drill bit / Hammer / Spirit Level / Measuring Tape / Screwdriver (Phillips) / Stanley Knife / Wood Saw / Step Ladder.

PLEASE NOTE: You are advised to pilot drill all screw holes and ensure all screwheads are countersunk.

CUSTOMER SERVICE: If there are any queries regarding the building construction or aftercare please contact the supplier of the building who will do their utmost to ensure customer satisfaction.

ADDITIONAL SAFETY RULES AND GUIDELINES:

- No one should use the equipment until properly assembled.
- Read the instructions thoroughly a couple of times before attempting each section of the build.
- Make sure you have adequate space, a safe working environment and a flat level base to work on.
- Take your time, do not panic.
- Construct your building within one month of delivery to stop parts warping / bowing.

ADDRESS: Kybotech Ltd, Parry Business Park, Grassthorpe Road, Sutton-on-Trent, Newark, Notts, NG23 6QX

CUSTOMER SERVICES: 01683 858 377

PRODUCT MAINTENANCE CHECK LIST:

Wooden Sheds / Playhouses / Summerhouses

- Level Base:**
A firm level base and protection from moisture penetration is key to maintaining the building.
- Seal The Windows:**
Use a silicone sealant on the inside and outside of the windows as soon as possible after assembly is a strong way of sealing the windows.
- Annually Treat The Building:**
Treat your building after construction with a good quality water resistant treatment. Repeat this process annually inside and out.
- The Building Must Not Be In Contact With Anything:**
Overhanging hedges or trees must be cut back regularly as a branch may pierce the roofing felt or glazing and would allow water ingress.
- Regularly Check / Replace Damaged Felt:**
Check the felt regularly. Any damaged felt must be replaced.
- Lubrication:**
Use a suitable oil to lubricated all moving parts, such as hinges, for continued proper use.

CLADDING STYLE

Overlap: This style of cladding is very traditional and uses rough sawn timber.

This gives the panels their unfinished look and helps the building to blend in to it's natural surroundings. When the wood has dried through hotter weather knots may become loose, which is natural. Overlap is an economic solution for lower impact use.

Tongue & Groove: This style of cladding allows the timber to interlock giving greater strength to the building. It also creates a smoother finish and continuous lines throughout the panel. Due to the natural movement of wood the lines between tongue and groove panels may not marry up.

PANEL ORIENTATION

It is essential to ensure that the panels of your building are in the correct orientation. Assembly in the wrong orientation may lead to water ingress and deterioration.

BOARDS OVER HANG THE EDGE OF THE FLOOR

In most cases the lower edge of the panels overhangs the floor of the building and the panel is fixed to floor with screws through the frame on the inside of the panel.

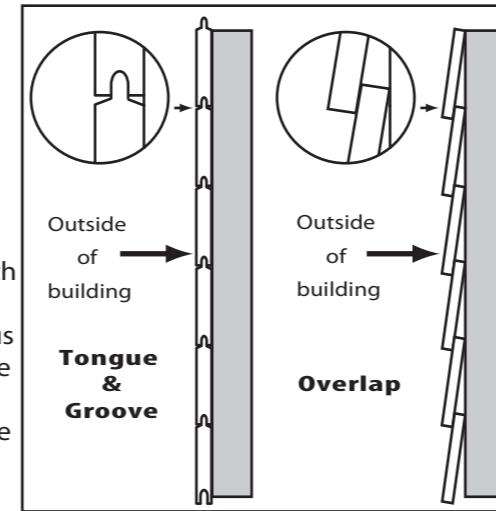

BUILDING A BASE

When thinking about where the building and base are going to be constructed ensure that there will be access to all sides for maintenance work and annual treatment. This building should be situated at least 2 feet away from any structures or obstructions (such as fences, buildings, trees etc). We recommend that areas around playhouses have a soft surface such as play bark or grass. **All garden buildings must be built on a level, flat base to be erected correctly.**

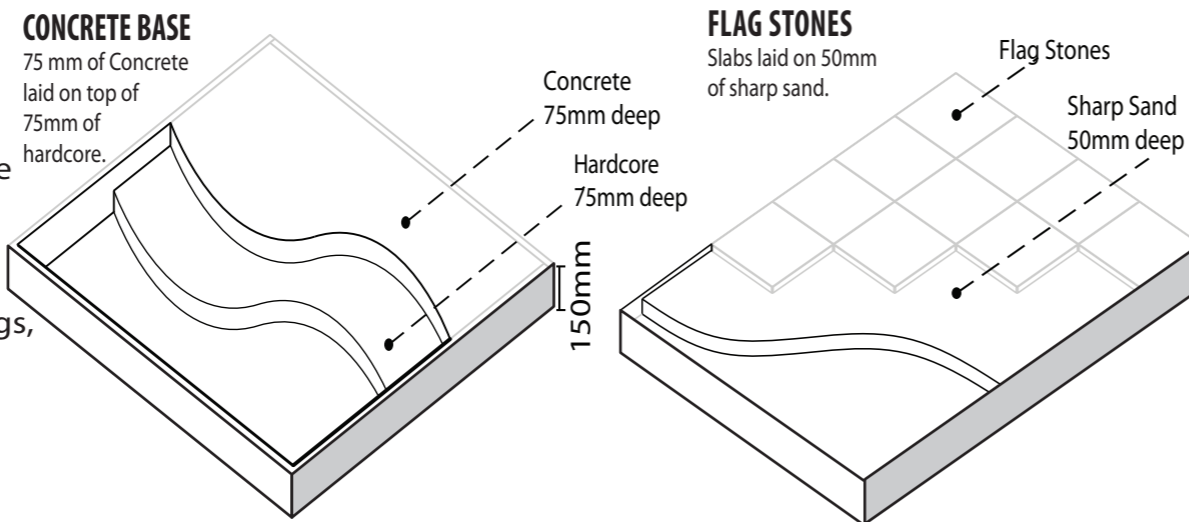

BUILDING DIMENSION TERMINOLOGY

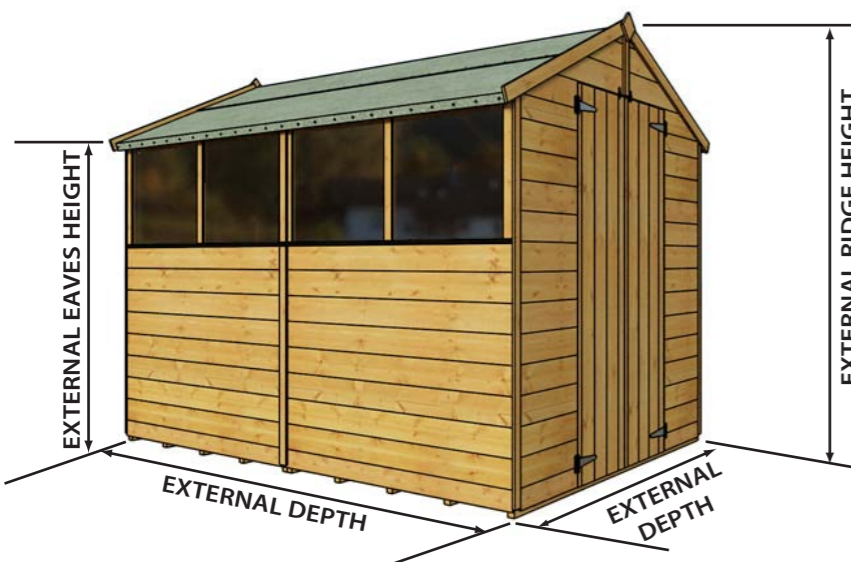

BASE DIMENSIONS

Use the dimensions that are on the technical details documentation for your specific building to work out the required dimensions when laying your solid base.

Do not forget about the roof overhang when choosing your building location. Keep in mind where the roof will finish and how you will maintain the building.

FLOORLESS BUILDINGS

For buildings that are bought without floors please go to this webpage to download the **NO FLOOR GUIDE** which will guide you in building a base for your floorless building:
www.billyoh.com/global/guides/NO-FLOOR-GUIDE.pdf

TROUBLE SHOOTING GUIDE

Pre-Assembly

Q: When is the best time to apply treatment? **A:** To truly cover all parts of the building, that will be exposed to the elements, you should treat your product with a high quality wood treatment before assembling the building.

Q: What type of base should I use? **A:** You must lay a solid flat / level base. Failure to do so will result in your building fitting together incorrectly. We highly recommend a properly laid and flat and level concrete or flag stone base (see Building a Base section of this instruction document).

Q: I have glazing / fixing kit missing. What should I do? **A:** Firstly check that all of your building's parts are there by laying them all out on the ground. Check between the panels / larger parts as the glazing comes banded together and is placed between the panels, along with the fixing kit, for safer transportation. If they are still not found please visit our Support Centre - www.gardenbuildingsdirect.co.uk/help

Q: What tools do I require? **A:** Drill with 4.5, 3 and 2mm drill bit / Hammer / Spirit Level / Measuring Tape / Screwdriver (Phillips) / Stanley Knife / Wood Saw / Step Ladder.

Q: Are my window & plain panels interchangeable? **A:** On apex buildings the window & plain panels are interchangeable where they are the same size or make up the same size panel as the opposing wall with more than one part.

Q: Can I have my personnel door on the other side of my building? **A:** Yes.

During Assembly:

Q: How are the windows fixed to the building? **A:** This process depends on the individual building. Please read the instructions to find out which method your particular building uses.

Q: Which way do the joists run? **A:** This process depends on the individual building. Please read the instructions to find out which way the joists run.

Q: My building seems a little flimsy? **A:** Your building won't reach full rigidity until fully assembled so do not panic.

Q: Construction seems tricky? **A:** Take your time and read the instructions thoroughly. These buildings should be constructed by two people. If in doubt seek professional help.

Q: The felt seems a little tight? **A:** To reduce waste, to help protect the environment and reduce costs for our customers we only supply the required amount of felt or roofing material.

Q: My building isn't going together properly, it is twisted. **A:** It sounds like you are building on an uneven surface. You must build on a flat / level base for your building to fit together correctly.

Post-Assembly:

Q: Why is there a gap around the doors? **A:** During the year the wood of your building will shrink and expand, which will create a gap around you building's doors. This is natural.

Q: My building is not water tight around the windows. **A:** These products have been designed as an affordable solution to most popular light domestic uses and we do not state that they are water tight. Use silicon sealant around the windows to improve the water resistant qualities of the building.

Q: My building has developed a leak **A:** Use silicon sealant to stop the leak and make sure that your building is not in a damp area and if necessary move it and replace the damaged boards.

TIPS ON GLAZING YOUR BUILDING:

1 To reduce wood splitting BLUNT ALL NAIL & PANEL PIN POINTS by hitting them with a hammer before fixing window parts.

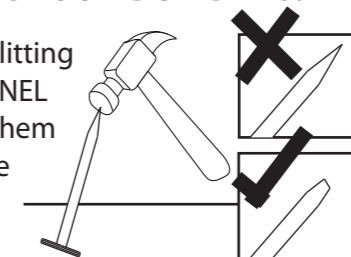

4 When fixing WINDOW BEADING get your nails or pins fixed in the beading away from the glazing before final positioning.

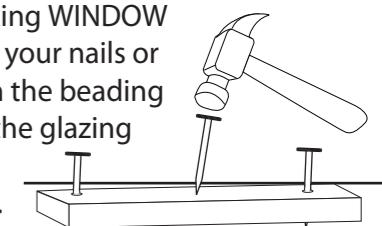

2 When fixing WINDOW CLOAKING STRIPS over two glazing panes make sure not to pierce the glazing beneath.

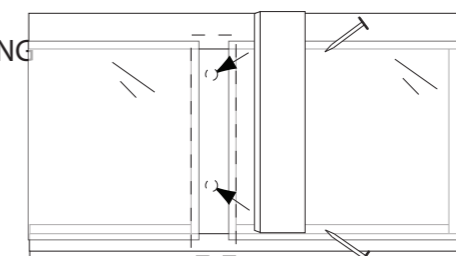

3 Use a piece of CARDBOARD to protect the glazing when fixing WINDOW CLOAKING STRIPS, WINDOW BEADING or WINDOW CROSSES.

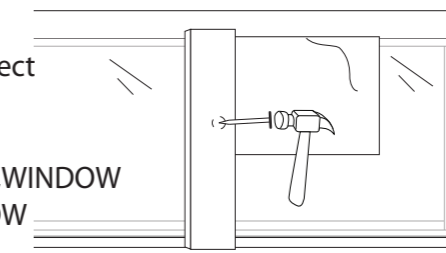

5 In hard to reach areas when glazing and fitting CLOAKING STRIPS try using a hammer and 6" inch nail to fix the nails and pins.

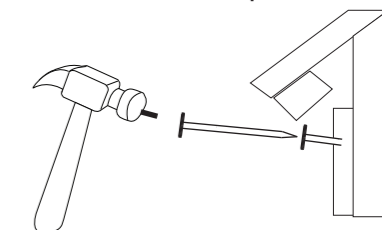

U1455 - 20 , 30 Classic Windowed 8ft - Gables (2015)

3x8

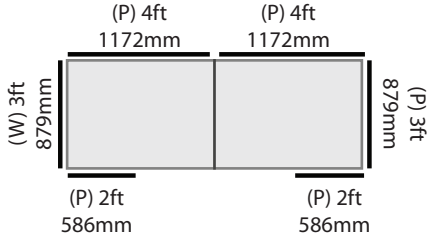

4x8

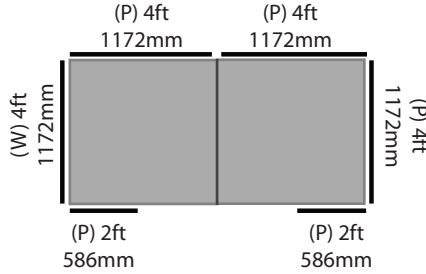

6x8

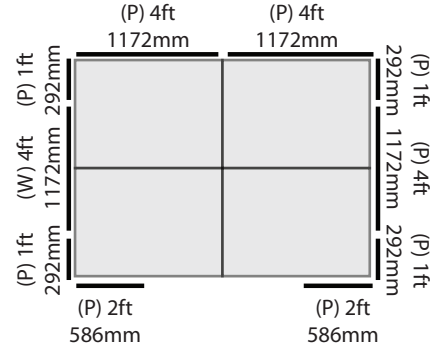

8x8

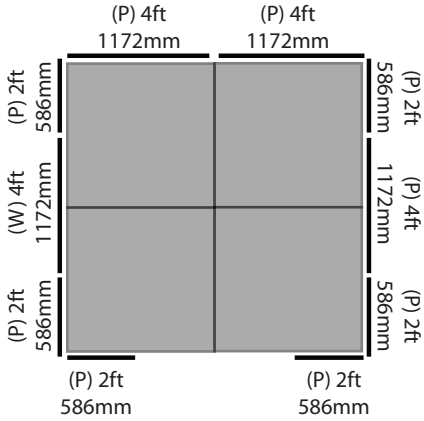

10x8

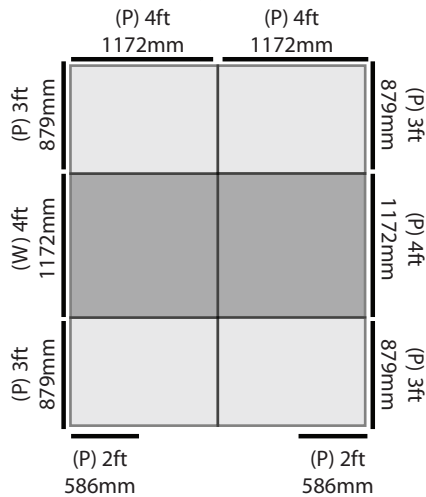

12x8

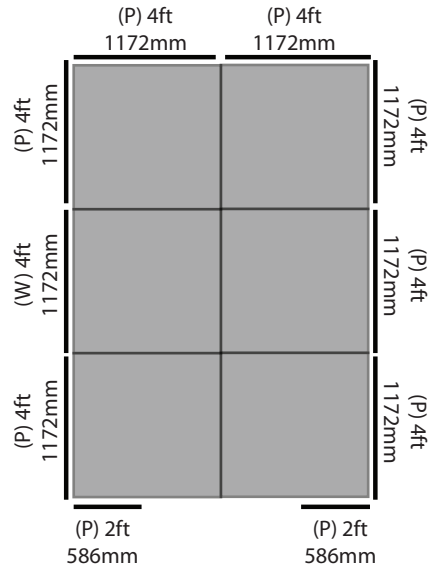

16x8

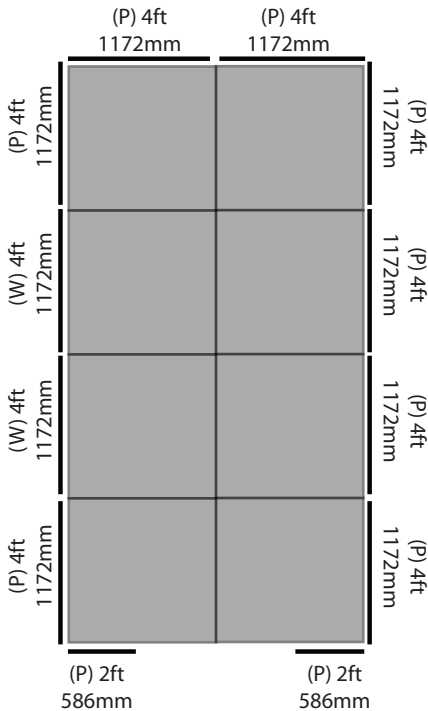

FLOORS USED:



14593-Assembled-SS-Floor-W(1199mm)xD(3ft/879mm)
14605-Assembled-TG-Floor-W(1199mm)xD(3ft/879mm)



14594-Assembled-SS-Floor-W(1199mm)xD(4ft/1172mm)
14606-Assembled-TG-Floor-W(1199mm)xD(4ft/1172mm)

U1455 - 20 , 30 Classic Windowless 8ft - Gables (2015)

3x8

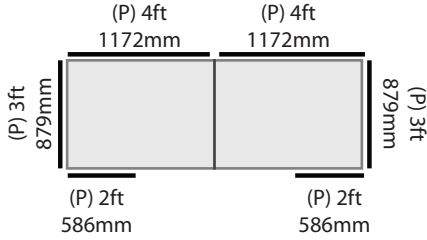

4x8

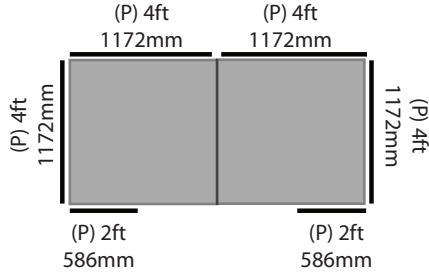

6x8

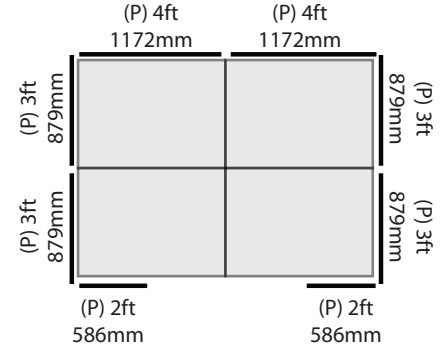

8x8

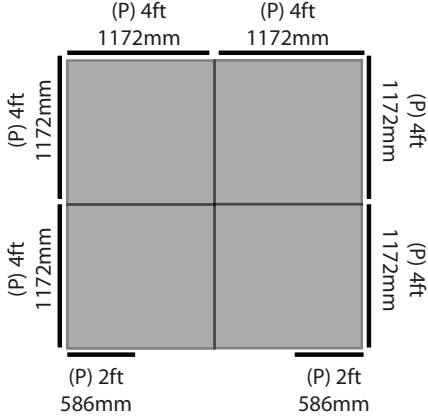

10x8

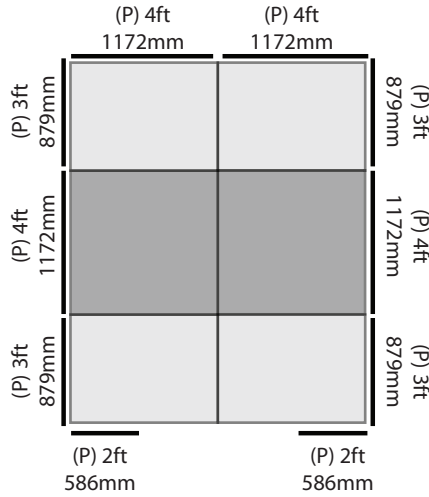

12x8

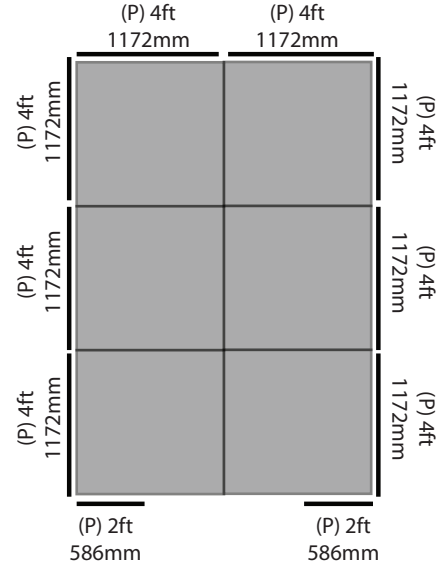

16x8

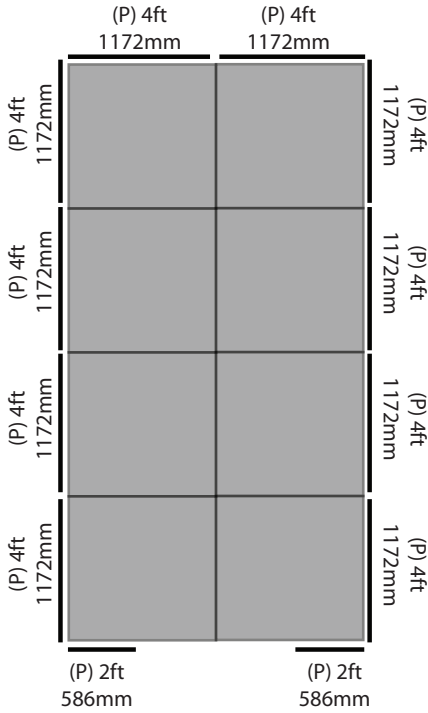

FLOORS USED:



14593-Assembled-SS-Floor-W(1199mm)xD(3ft/879mm)
14605-Assembled-TG-Floor-W(1199mm)xD(3ft/879mm)



14594-Assembled-SS-Floor-W(1199mm)xD(4ft/1172mm)
14606-Assembled-TG-Floor-W(1199mm)xD(4ft/1172mm)

Exploded View - 10x8 Windowed Double Door

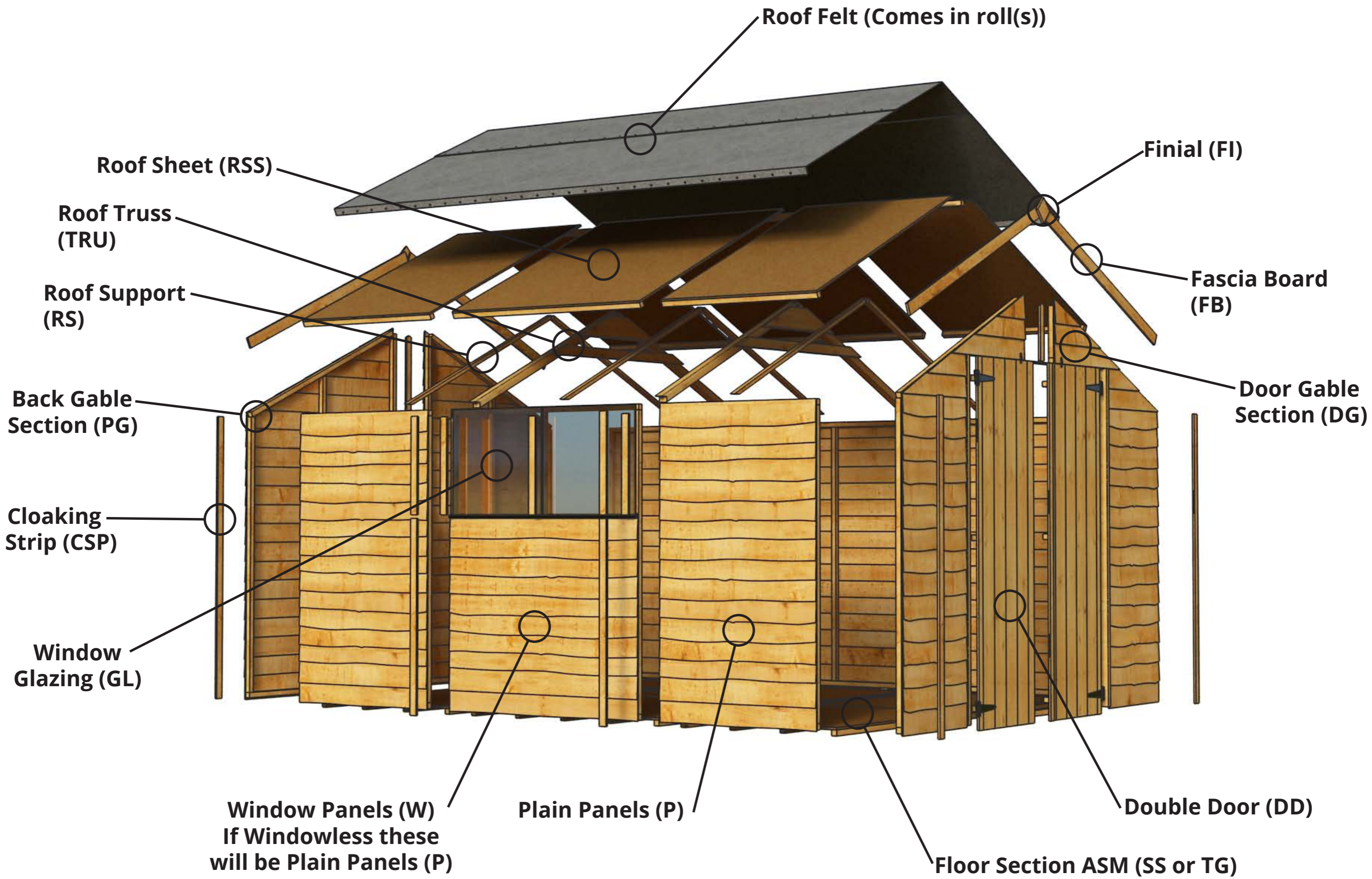

Exploded View - 10x8 Windowless Double Door

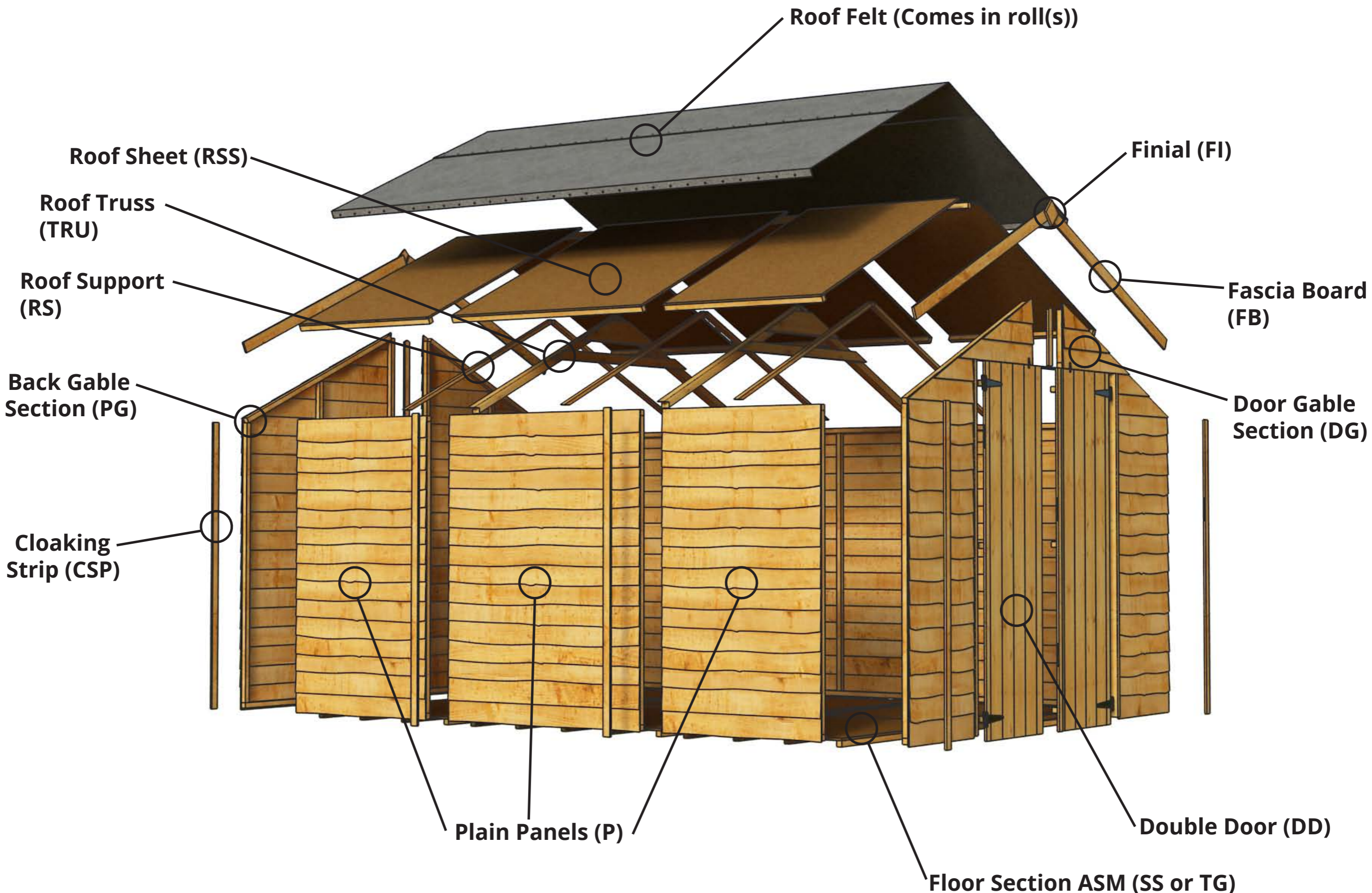

Exploded View - 8x8 Windowed Double Door

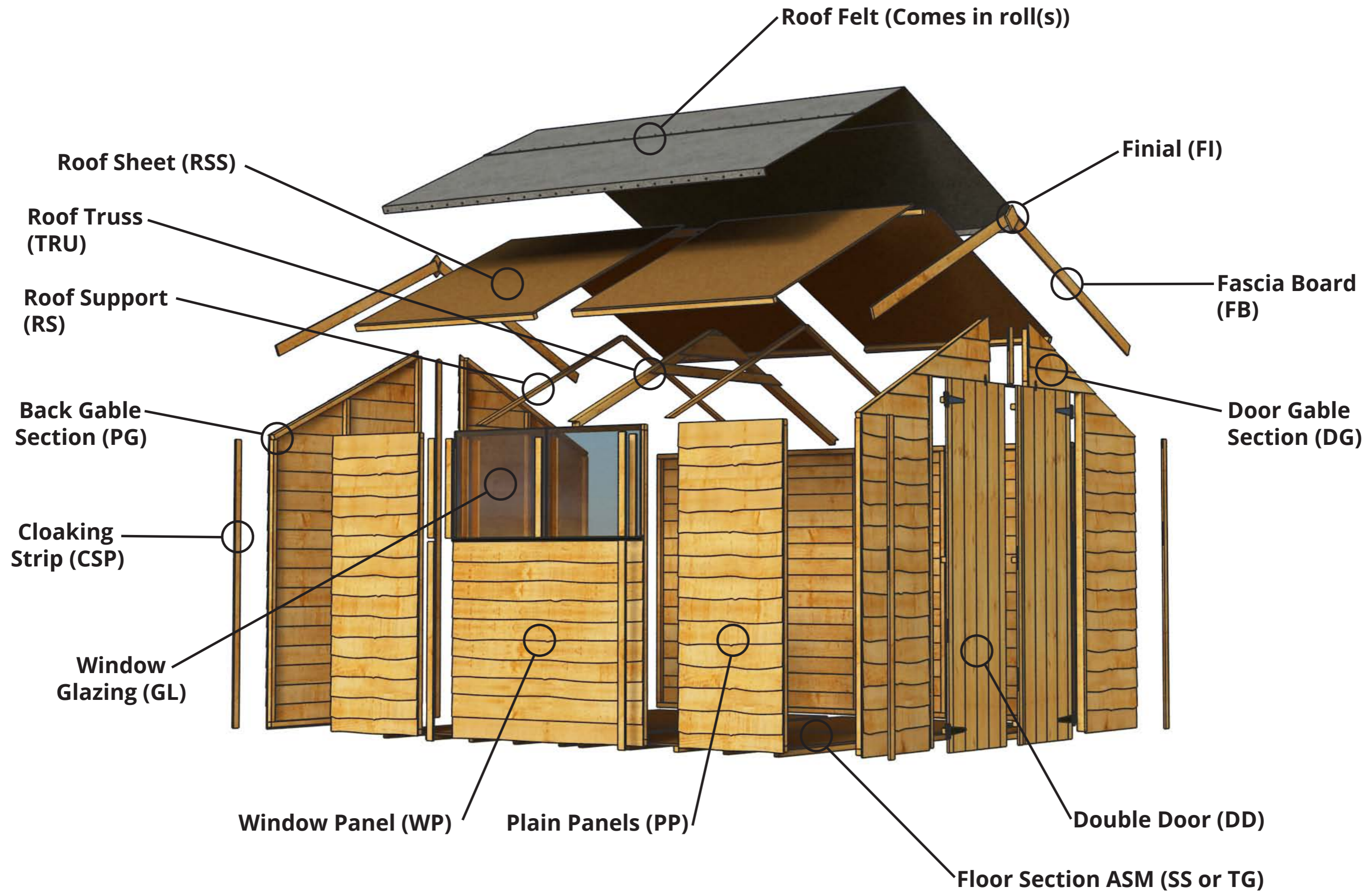

Exploded View - 8x8 Windowless Double Door

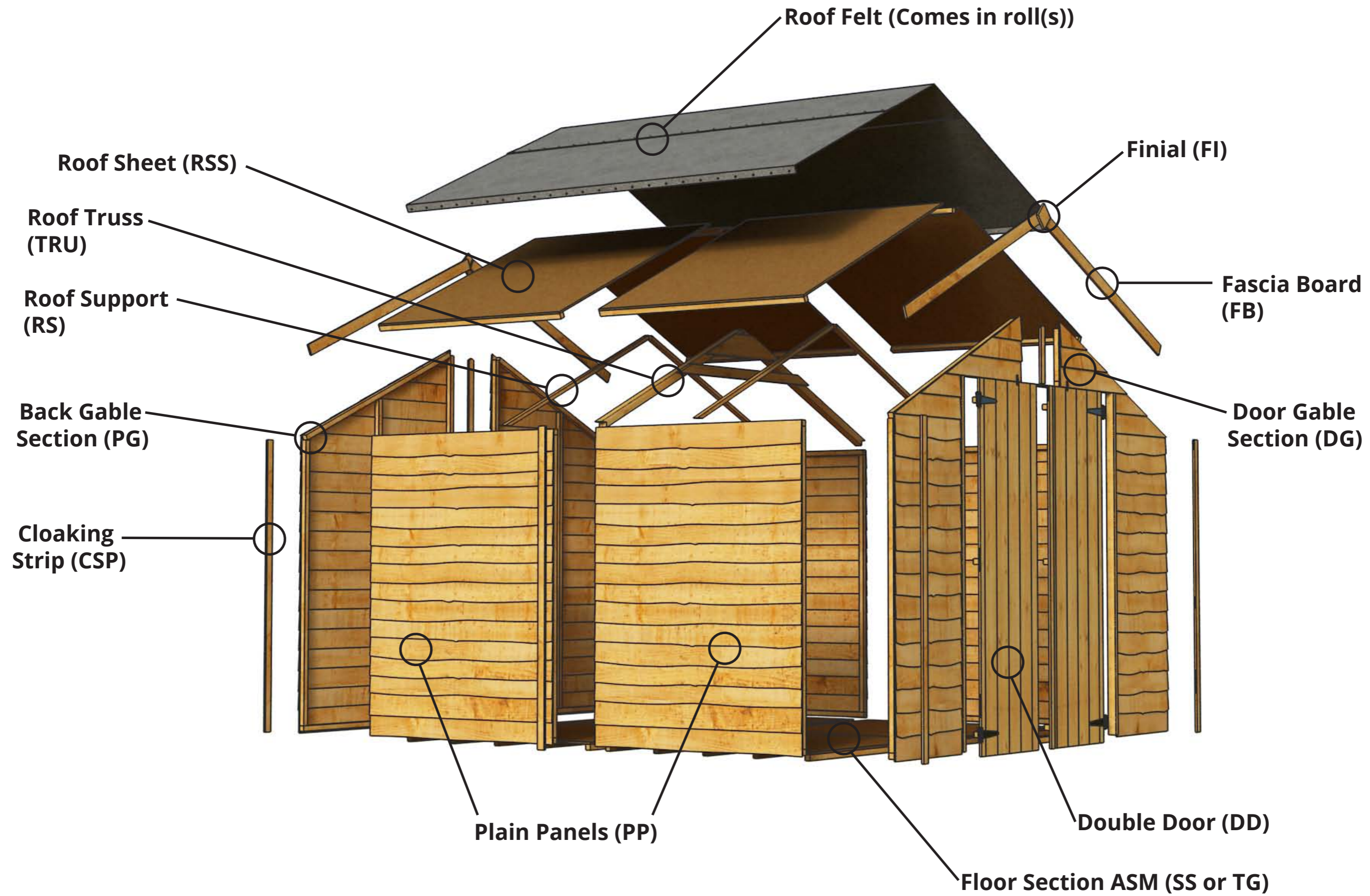

1 Floor Stages

Lay floor sections with Joists facing upwards

Back Side

The floor sections will be SS or TG

Skip to Stage 3 if your building only requires 2 floor sections.

2

S50 x 8

3

Back Side

Flip Floor back over with the joists running left to right

4 Wall Panel Stages

Place a 3ft or 4ft Plain Panel along the edge of the floor. It should line up with edges of the floor.

Back Side

5 Wall Panel Stages (6x8 and 8x8 Windowed Only)

Place a Plain Panel (PP) along the edge of the floor. It should fit flush with the back edge of the floor.

The sizes of the panels should match on each side of the building

Back Side

6

S50 x 3

Pilot drill holes before fixing

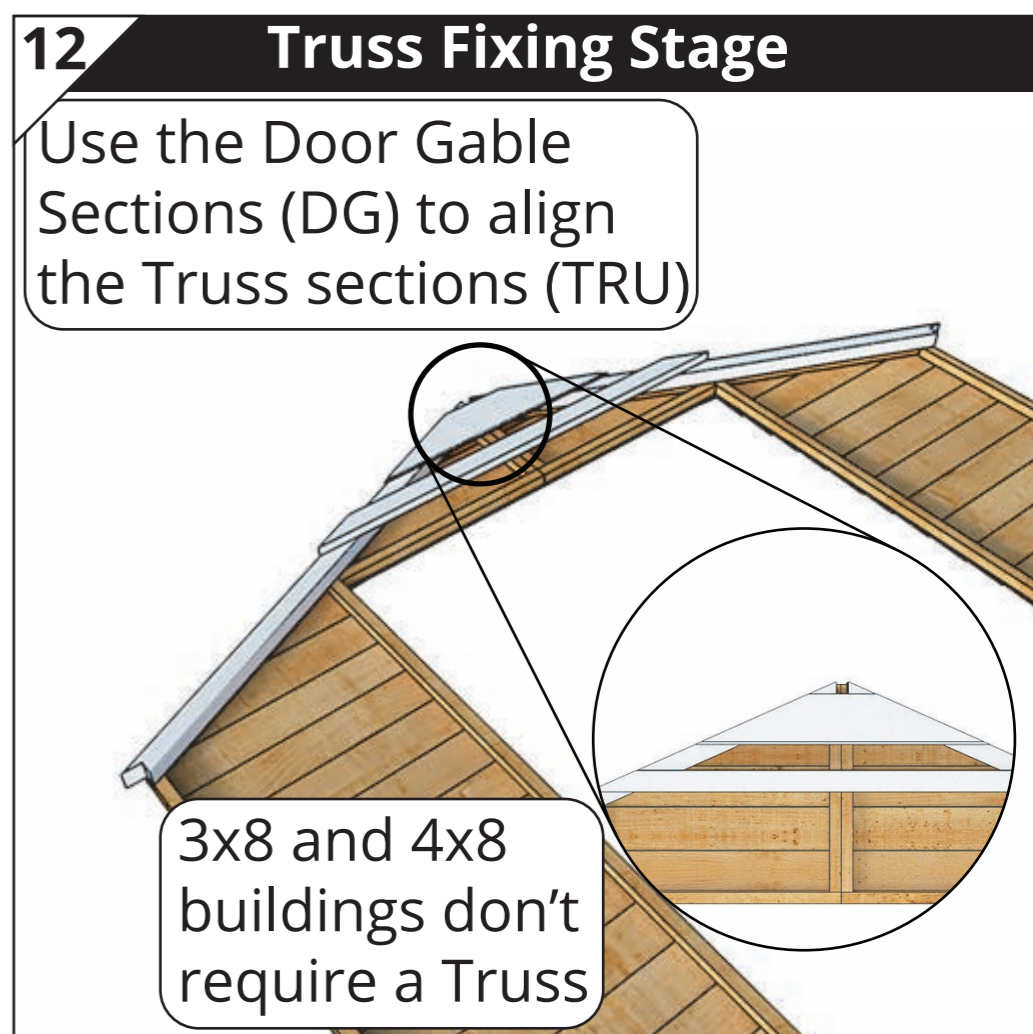
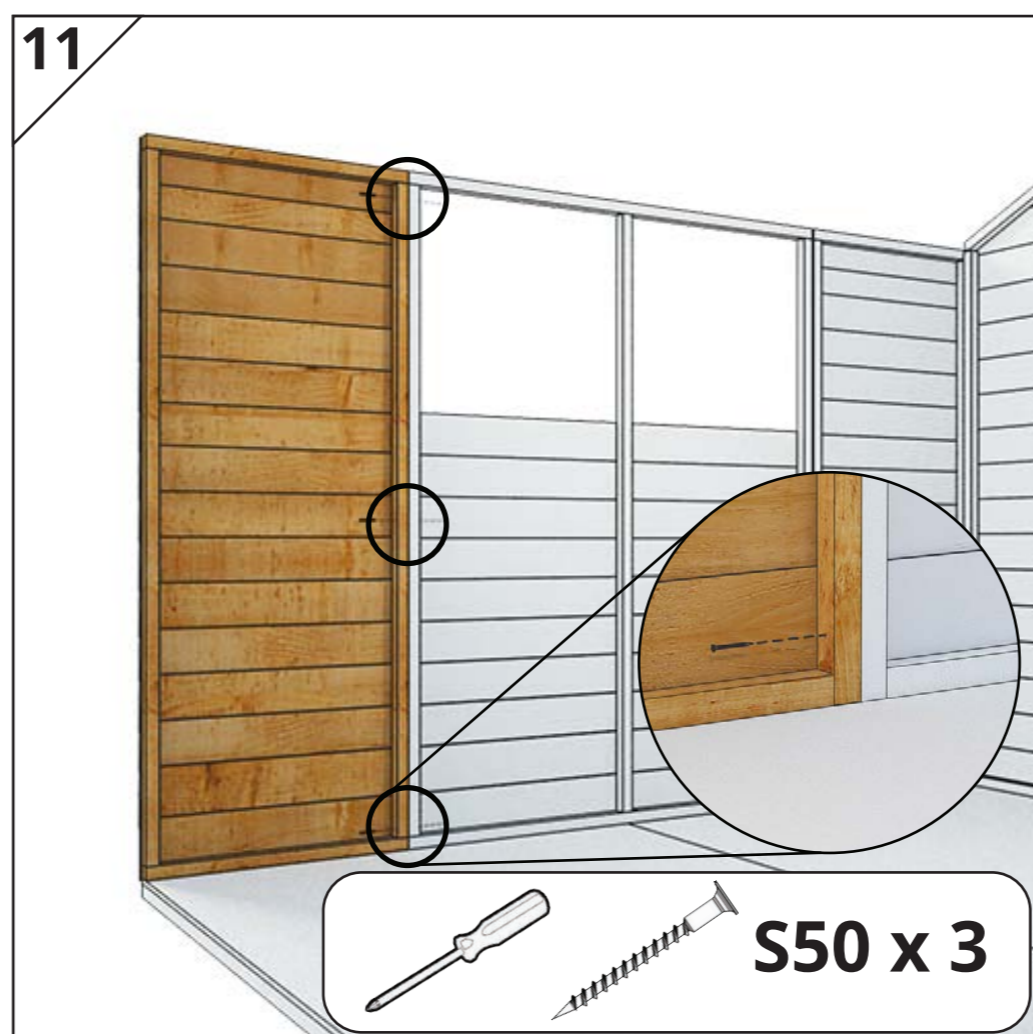
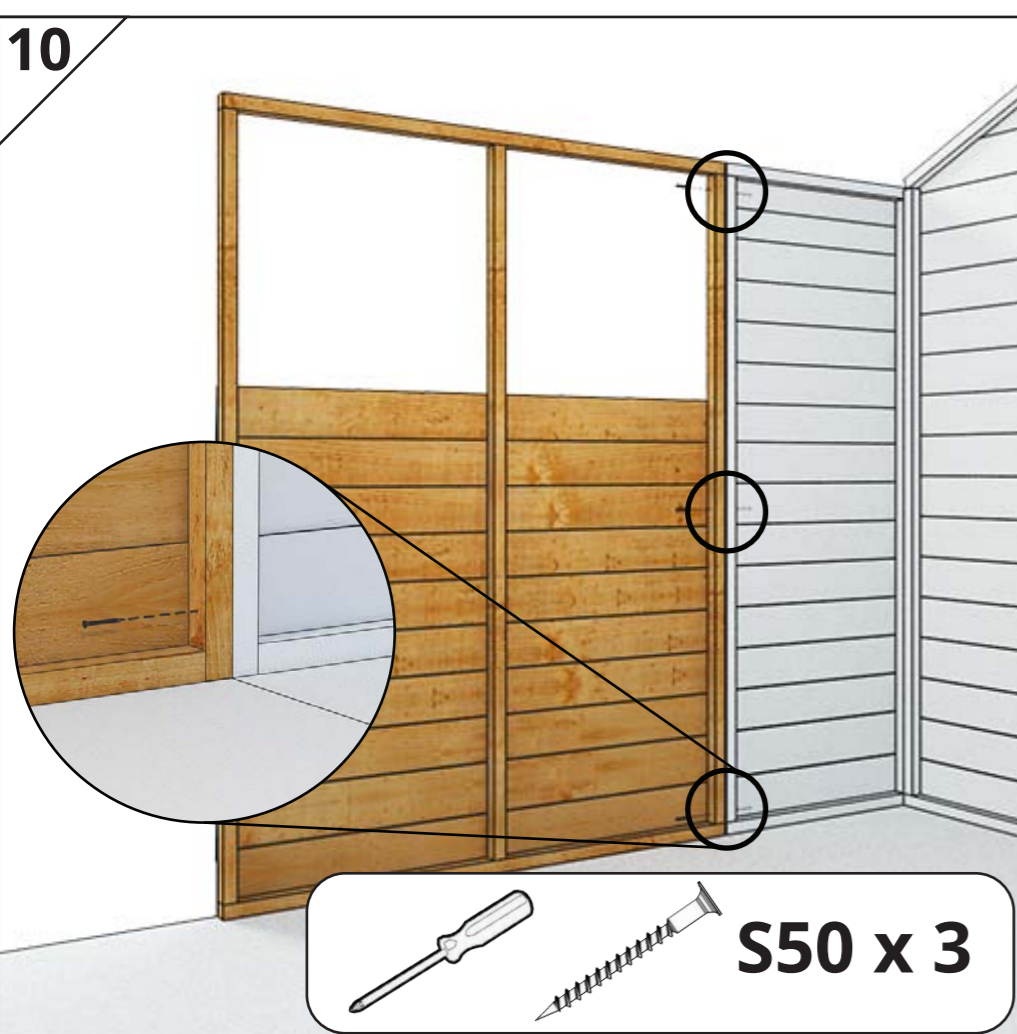
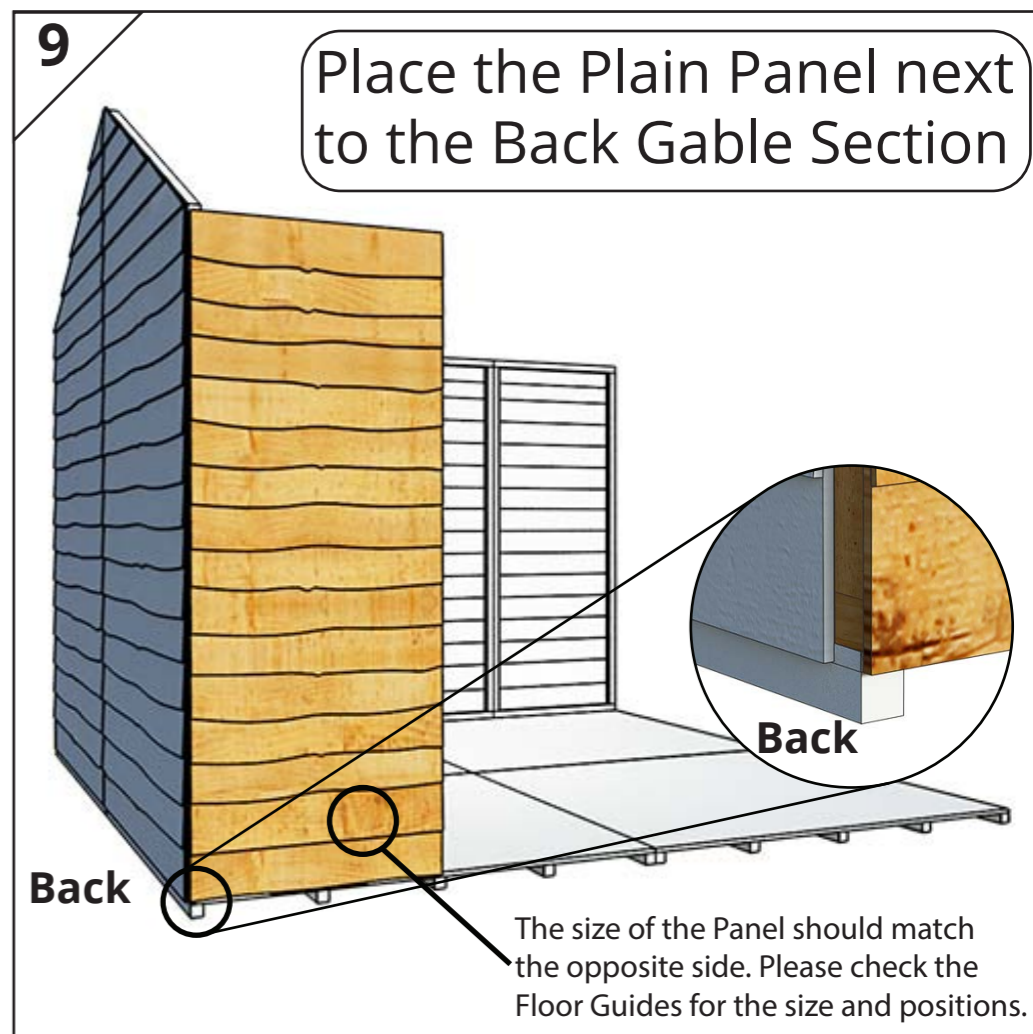
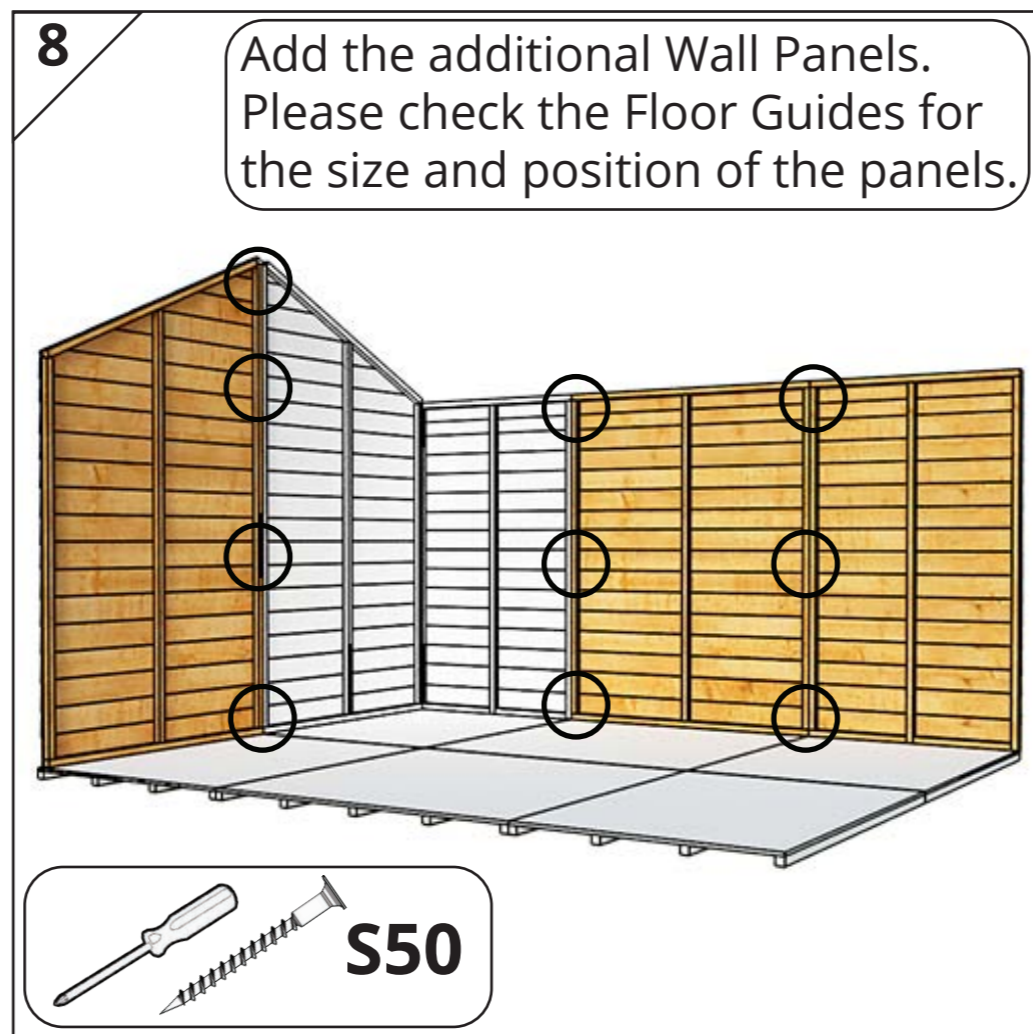
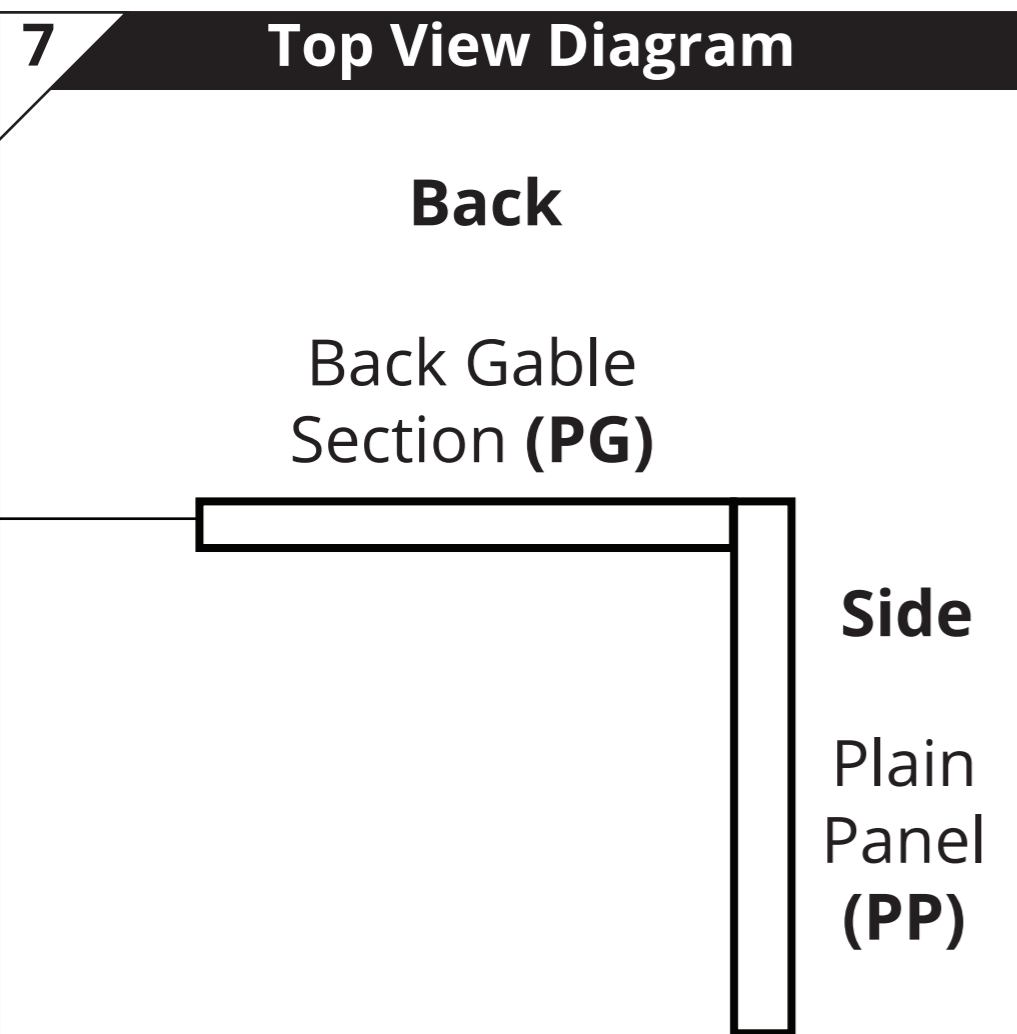

13 Fix the Truss pieces together

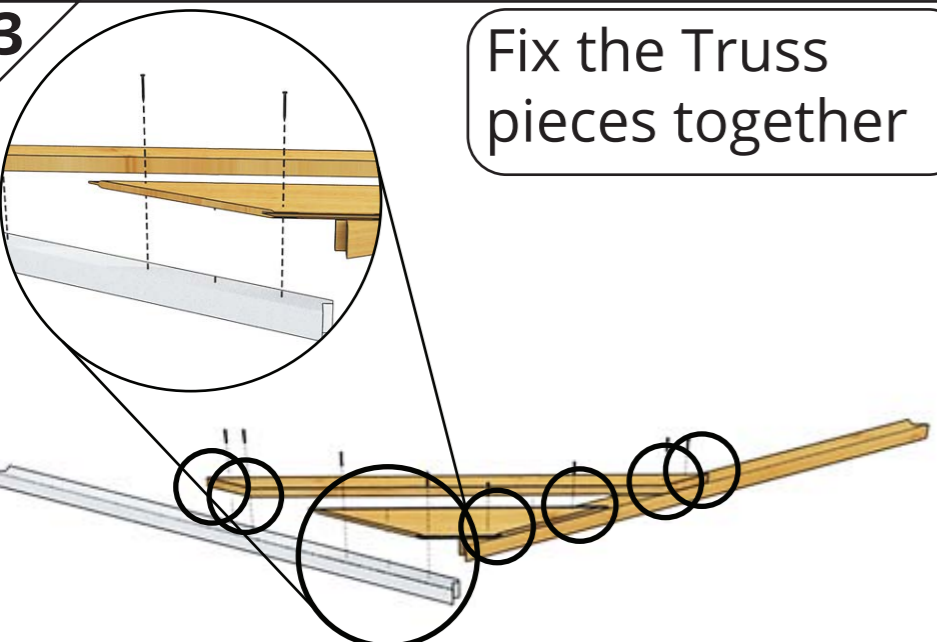

1317mm x 2
700mm x 1
1200mm x 1

N30 x 8

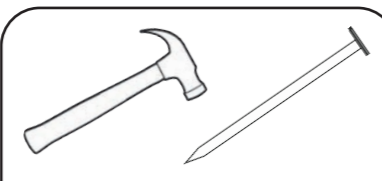
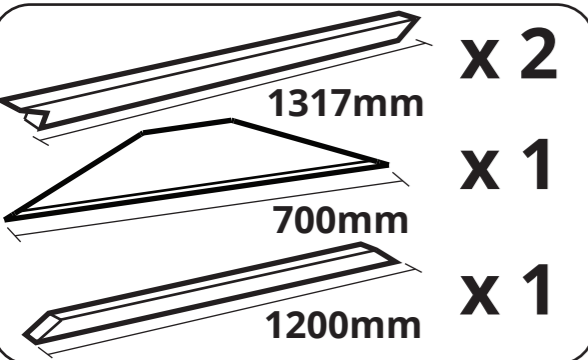

14 Place the Door Gable Section on the inside of the Side Panels

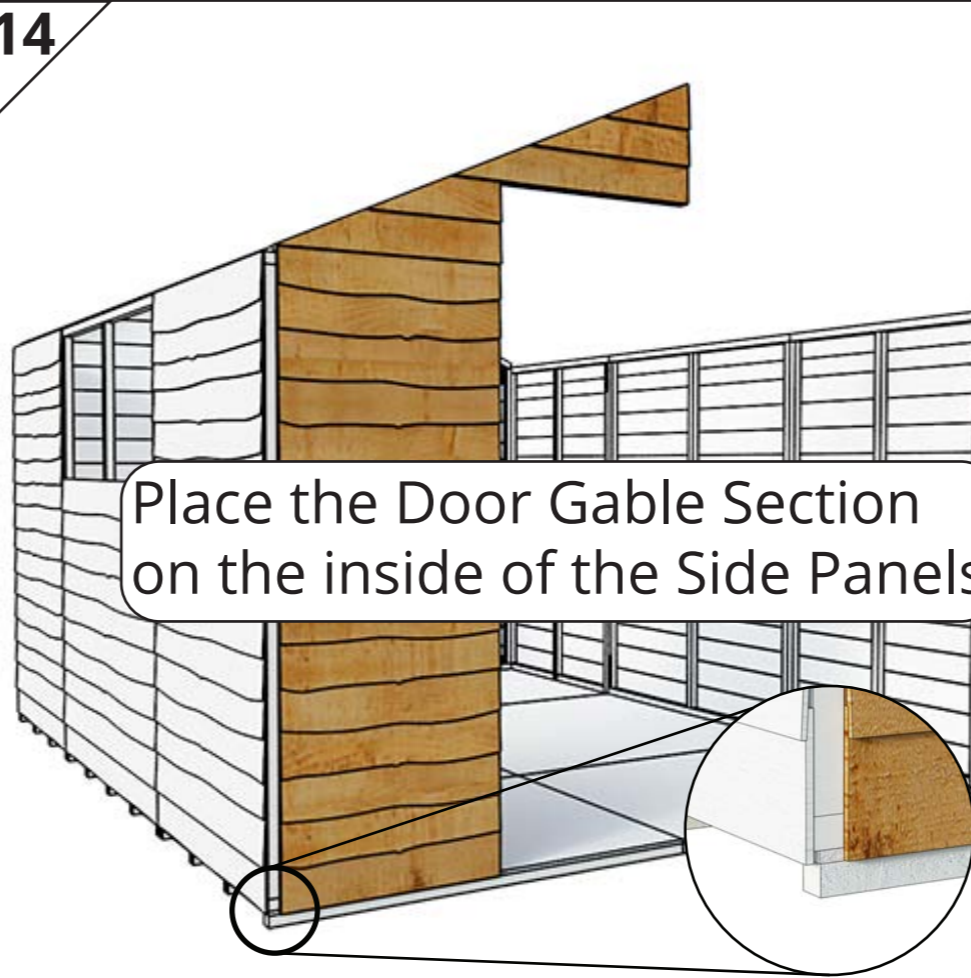

Place the Door Gable Section on the inside of the Side Panels

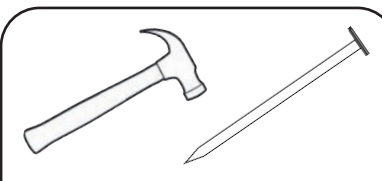

15



S50 x 3



16

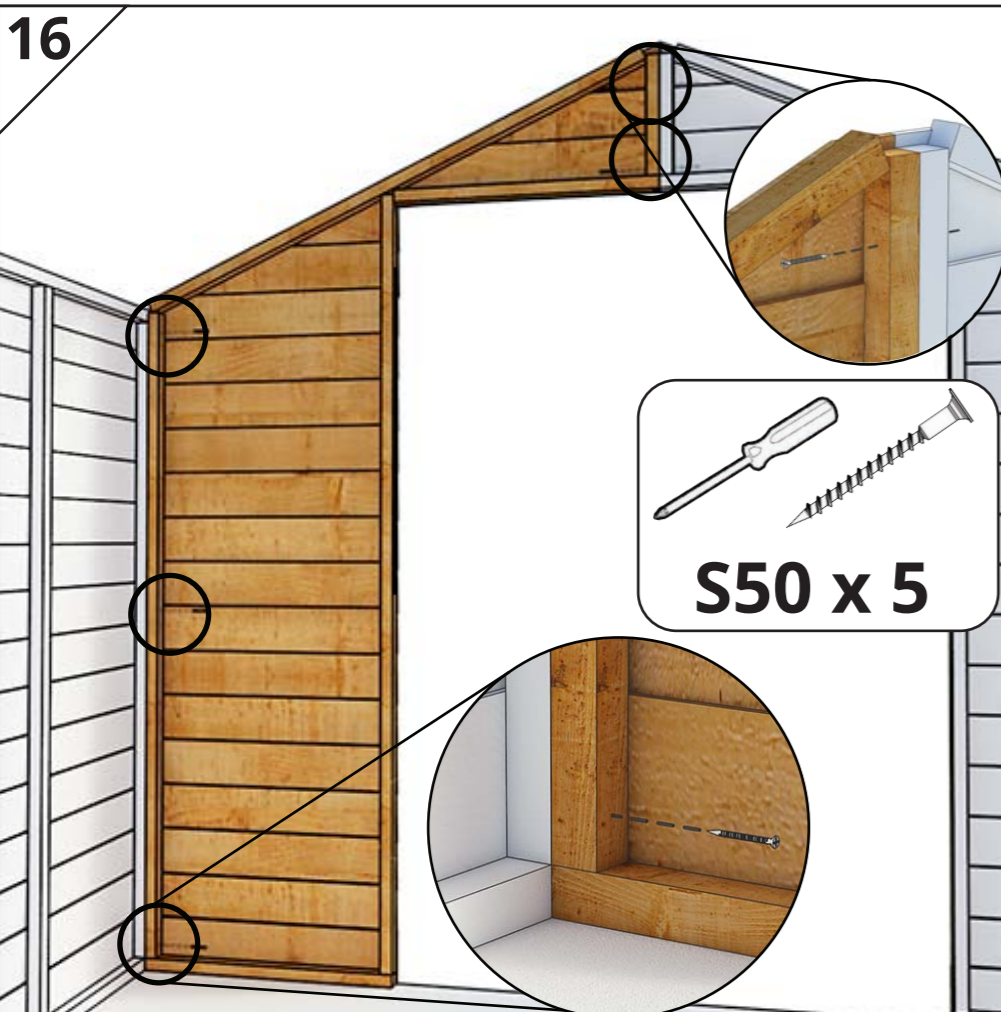

S50 x 5



17

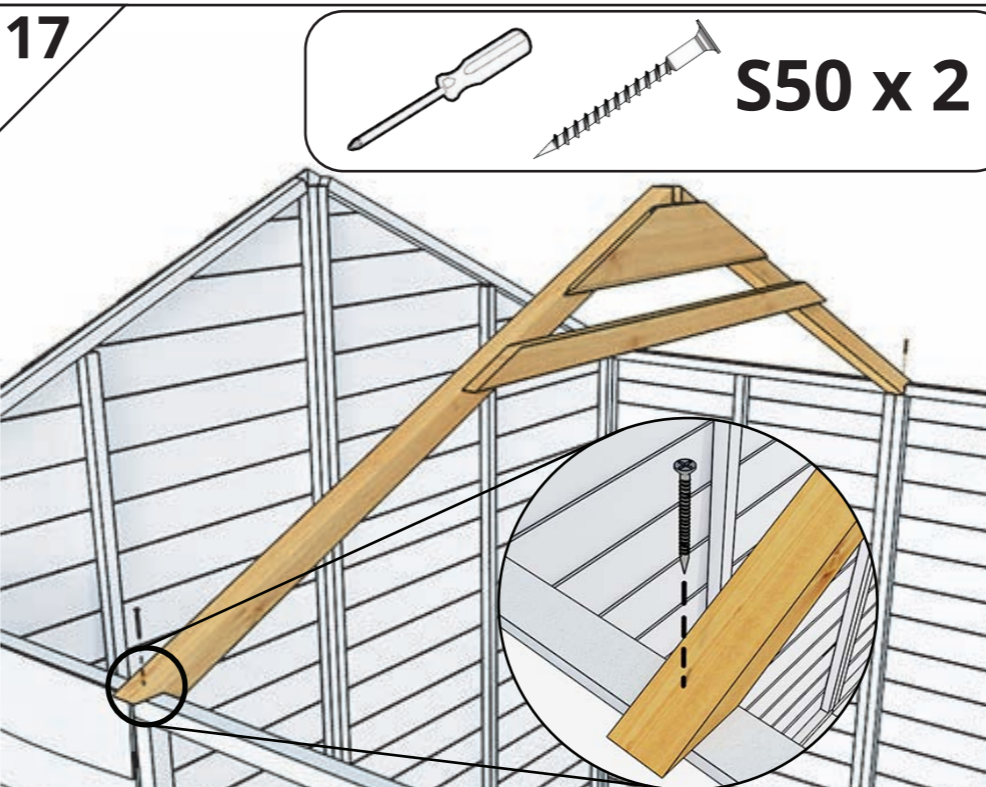

S50 x 2

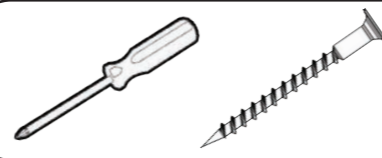

The Truss must be positioned where the Roof Sheets will meet. This will be either 879mm or 1172mm. Please see the diagram.

18 Truss Position Diagram

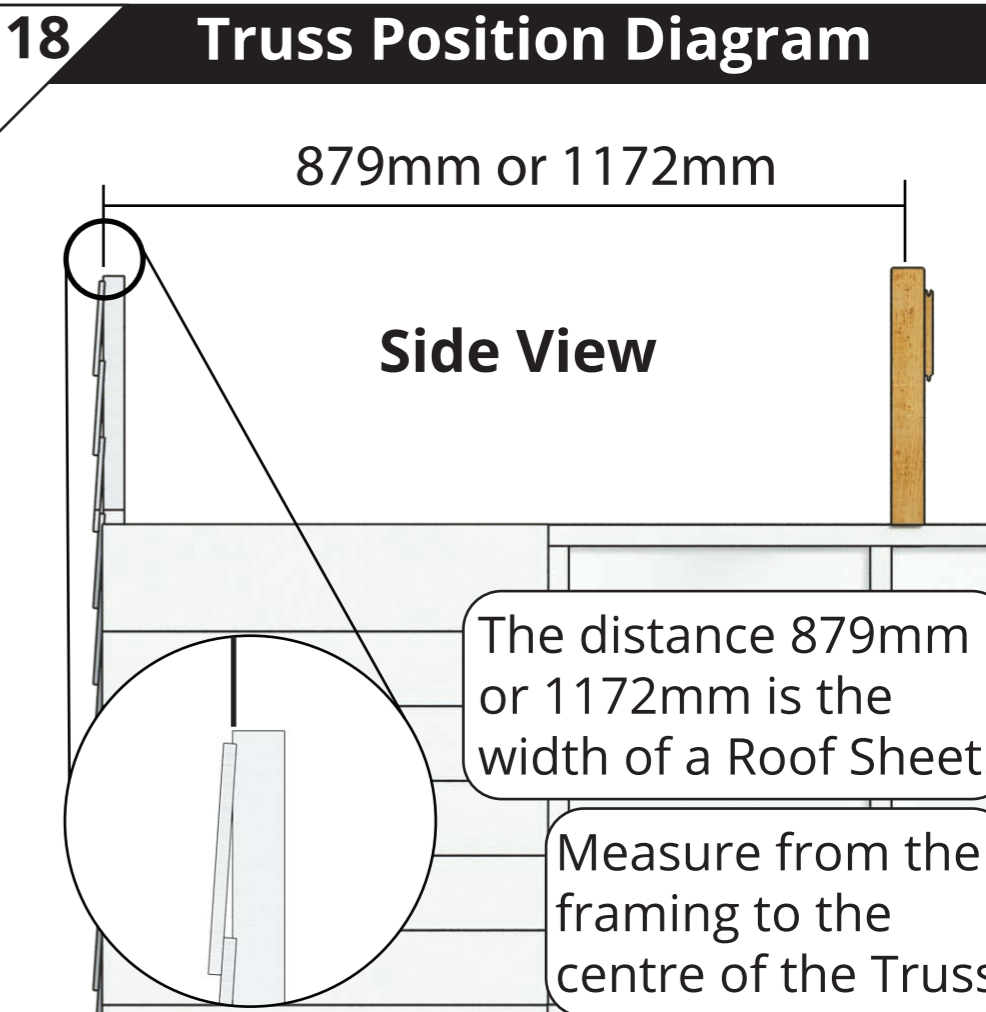

879mm or 1172mm

Side View

The distance 879mm or 1172mm is the width of a Roof Sheet.

Measure from the framing to the centre of the Truss

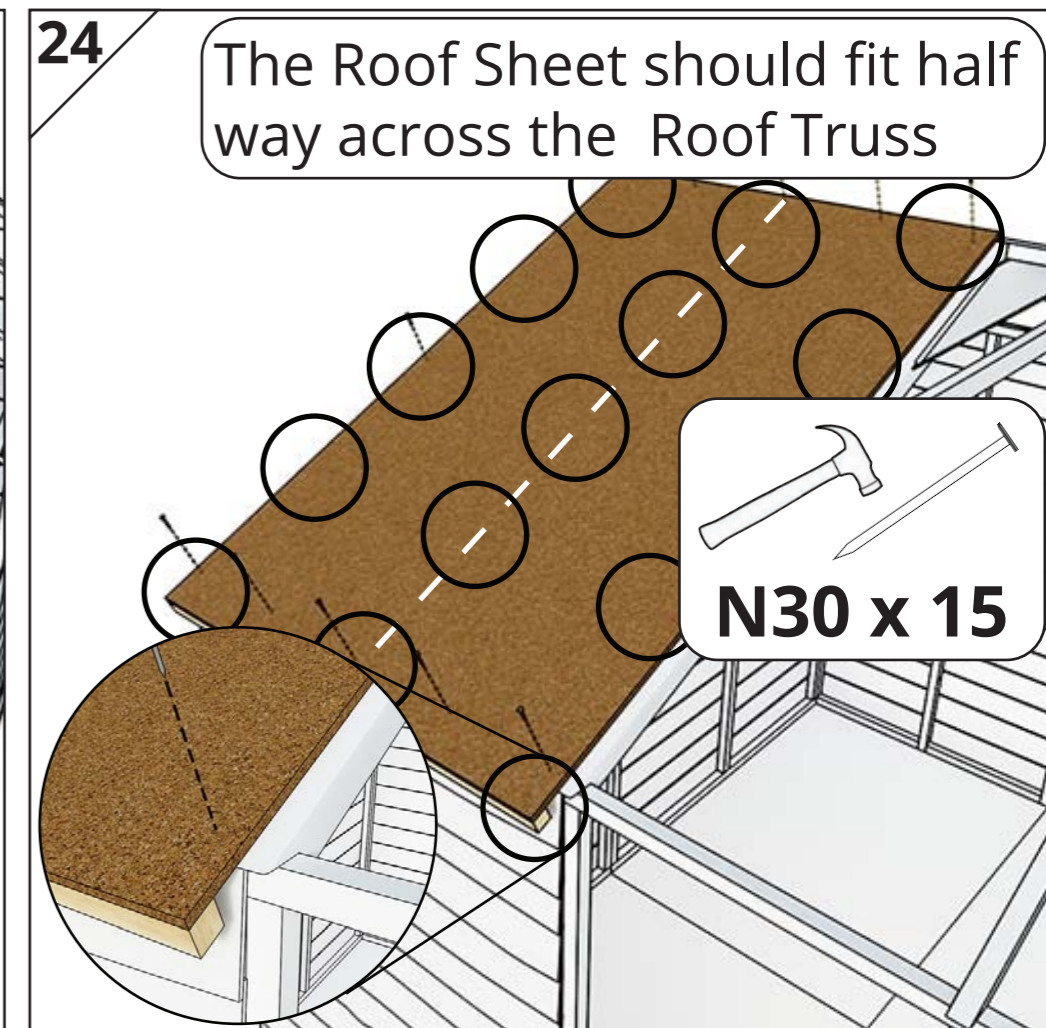
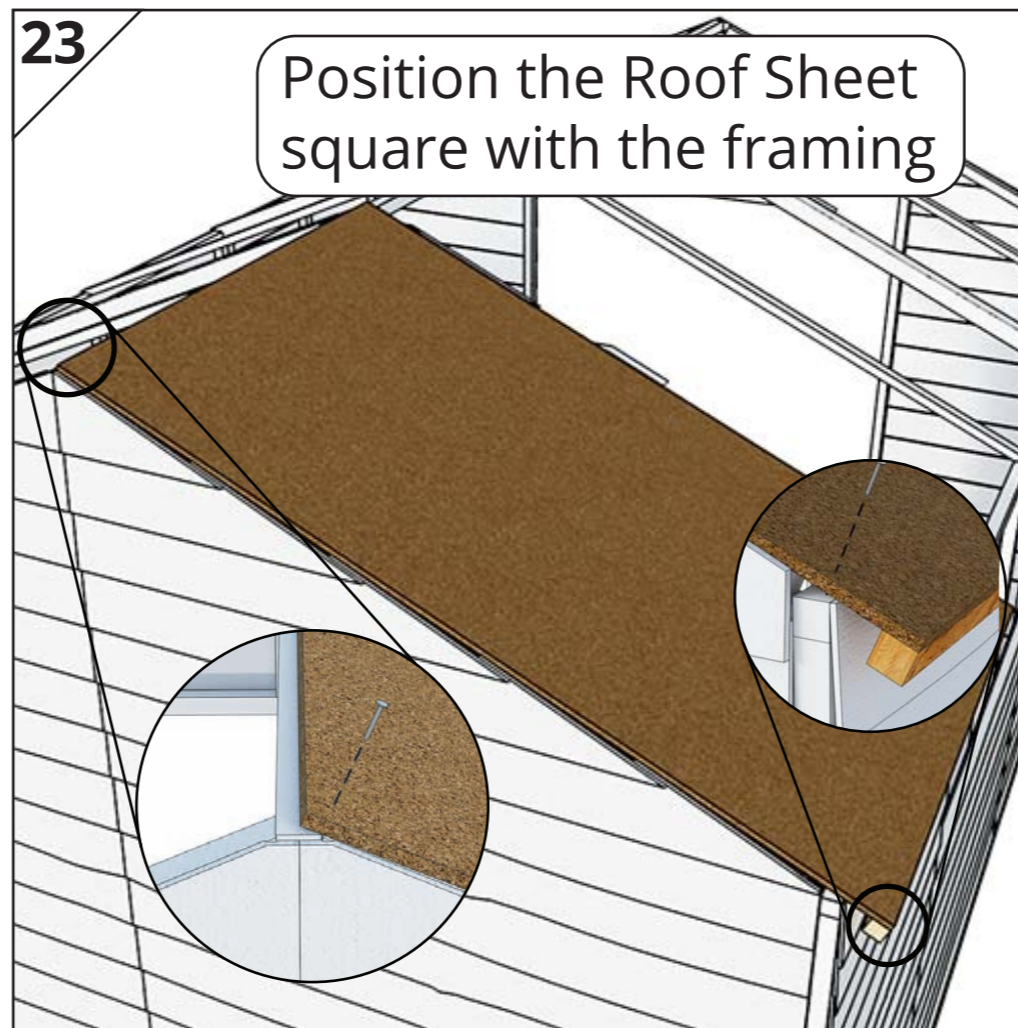
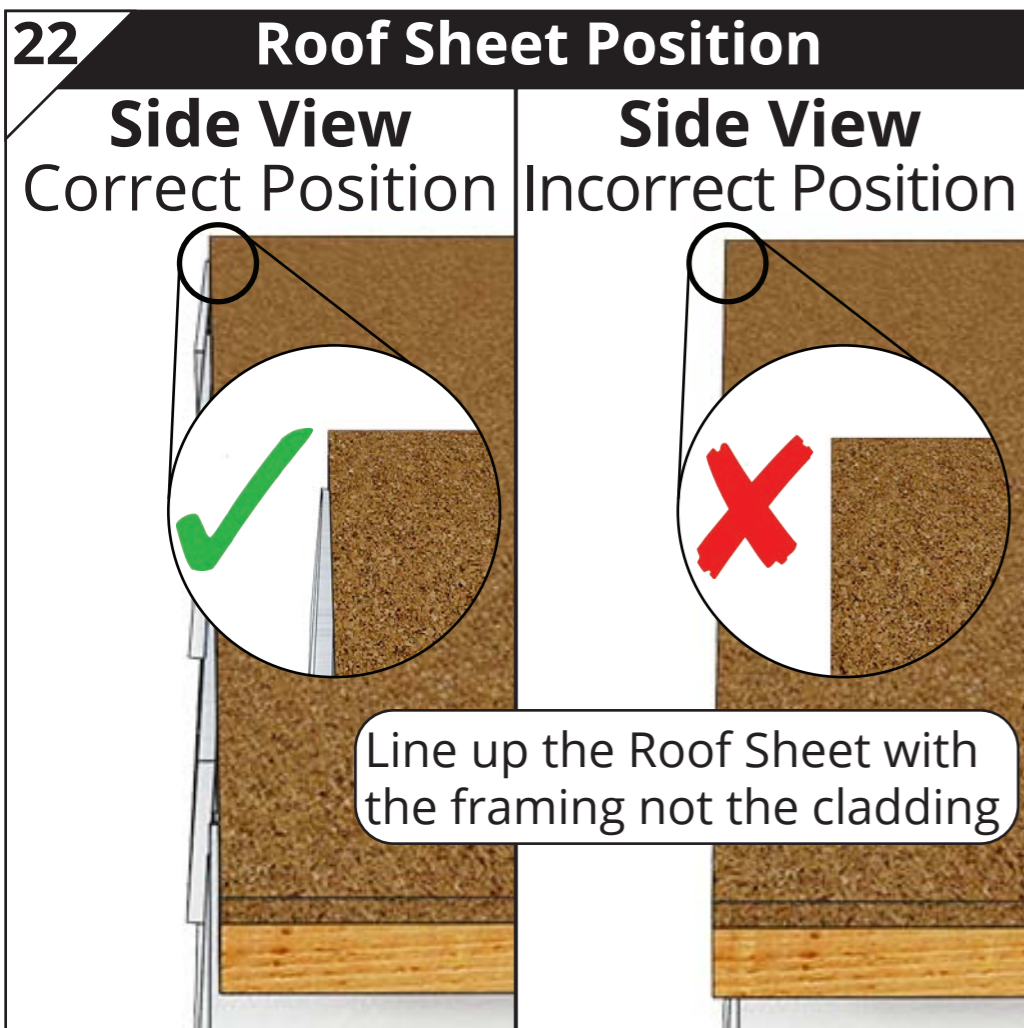
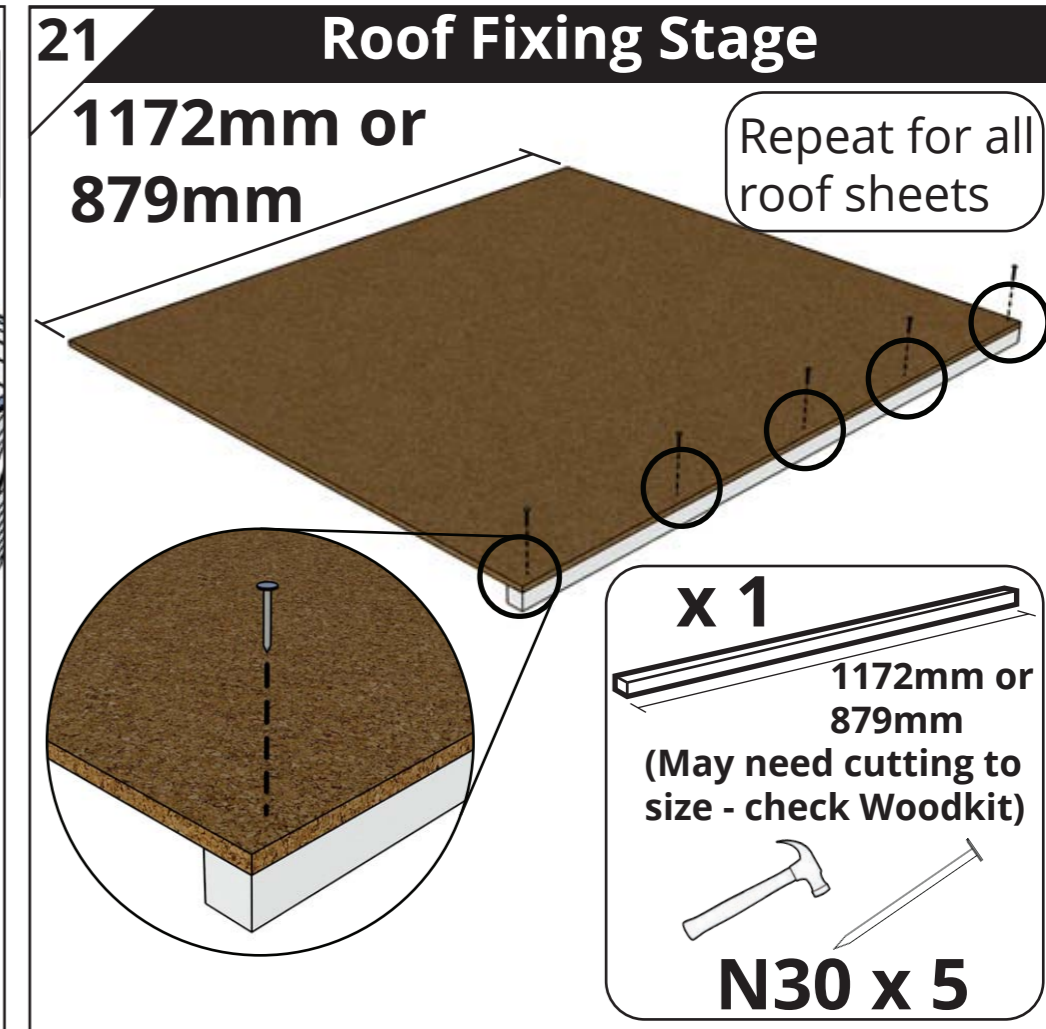
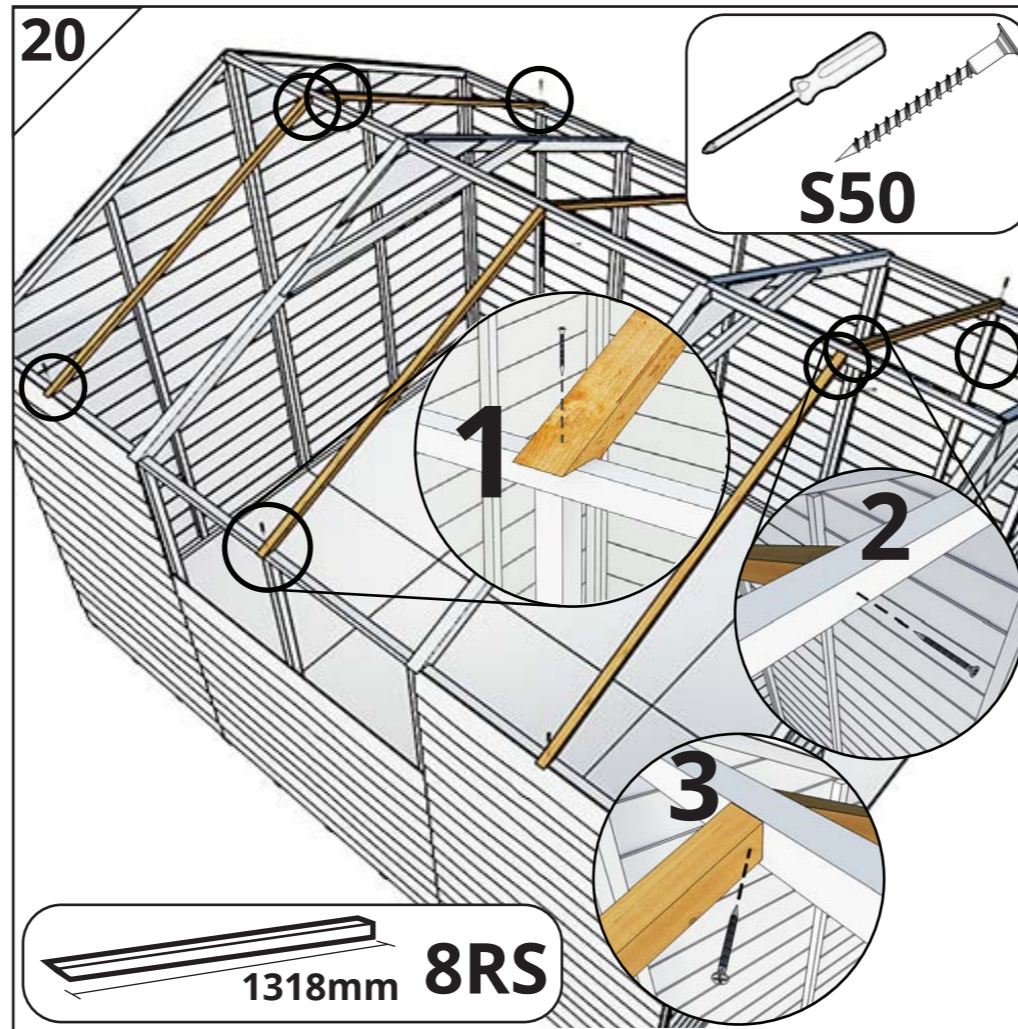
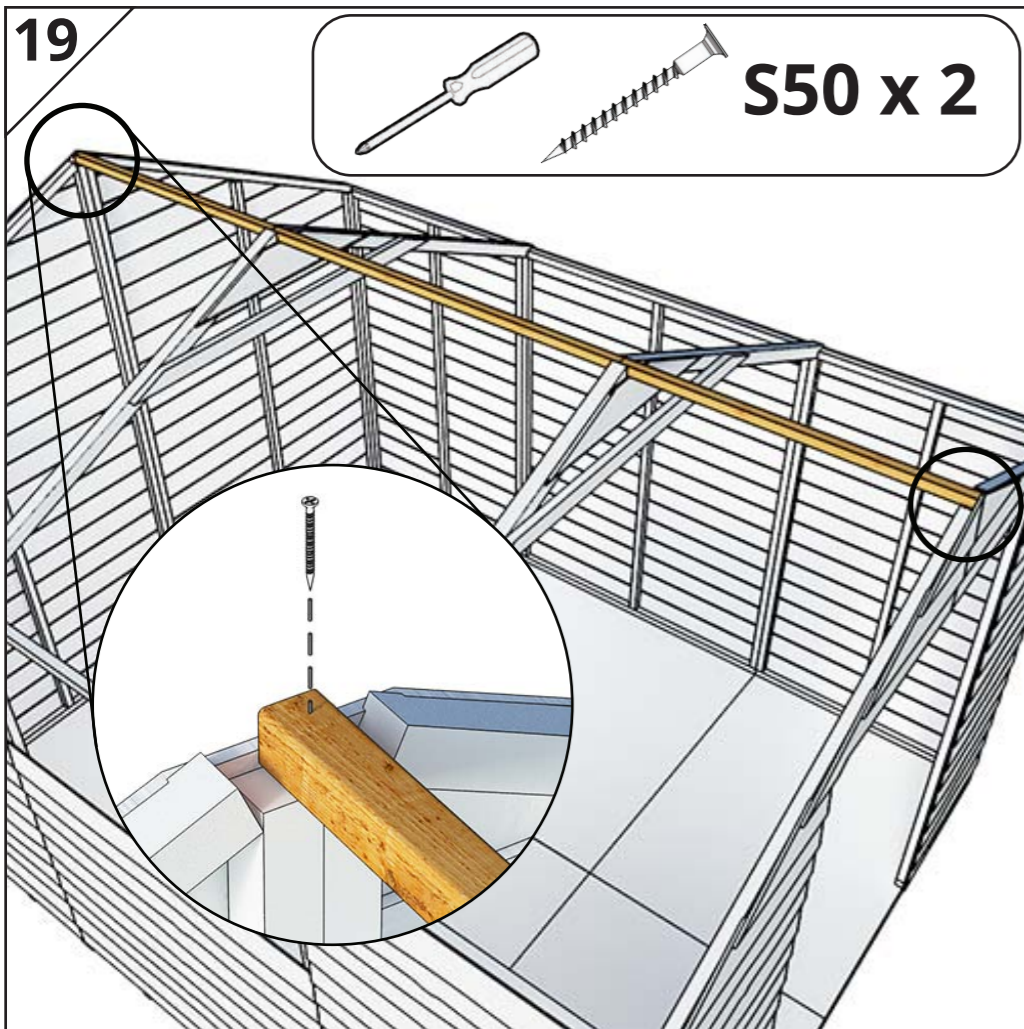

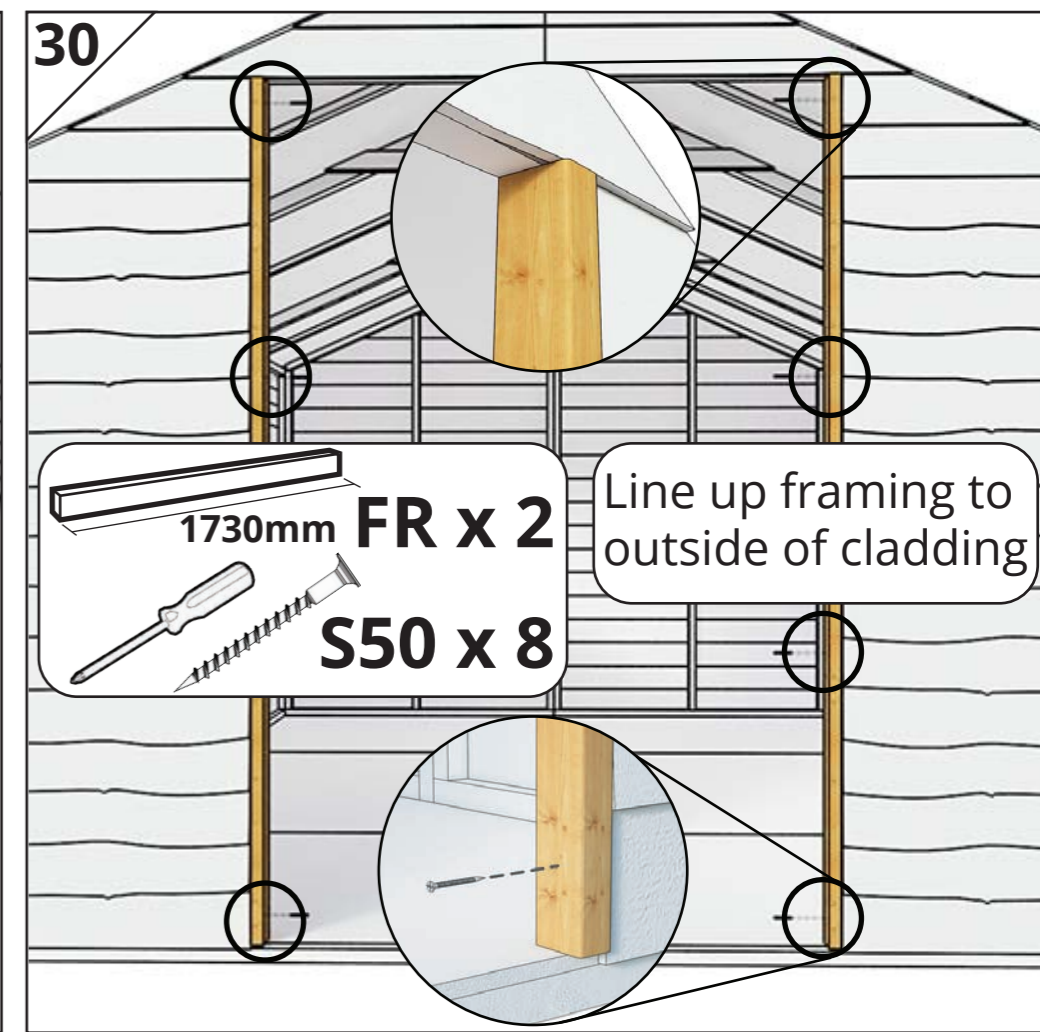
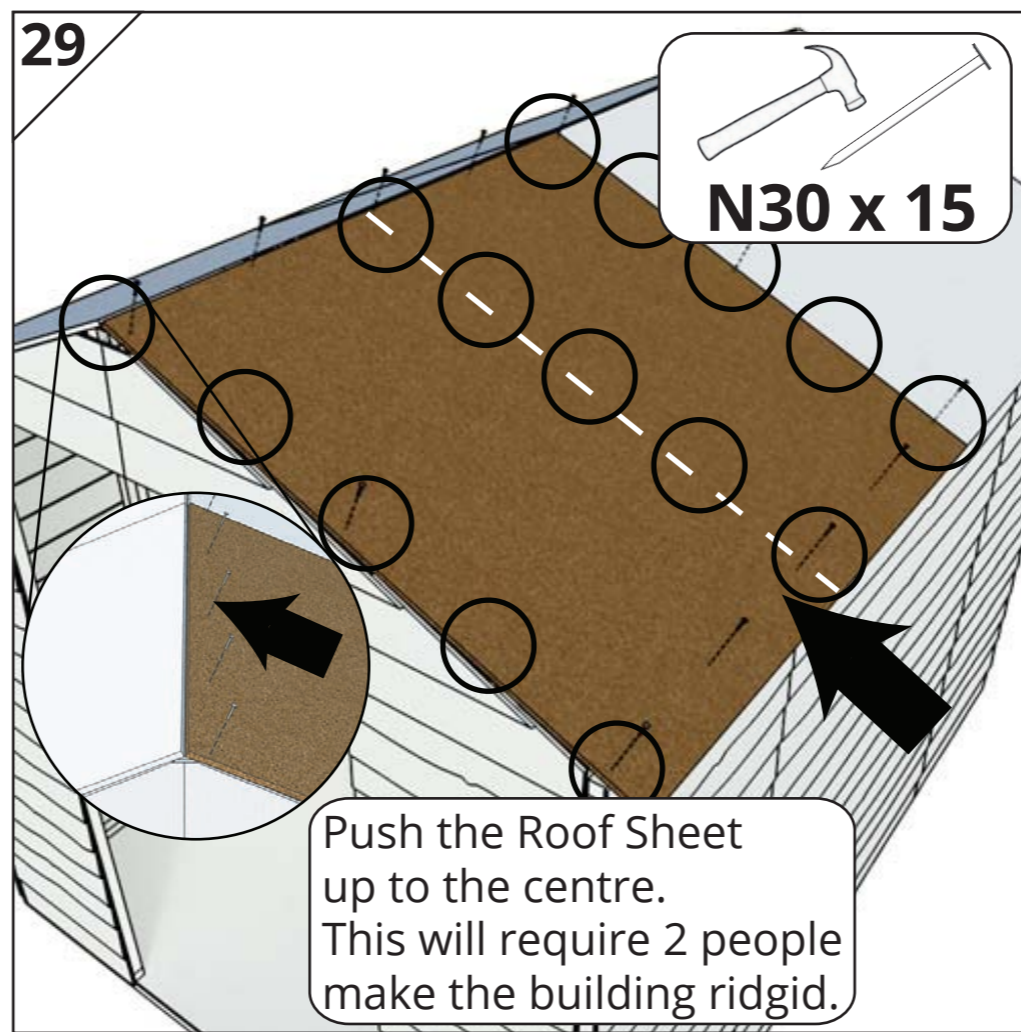
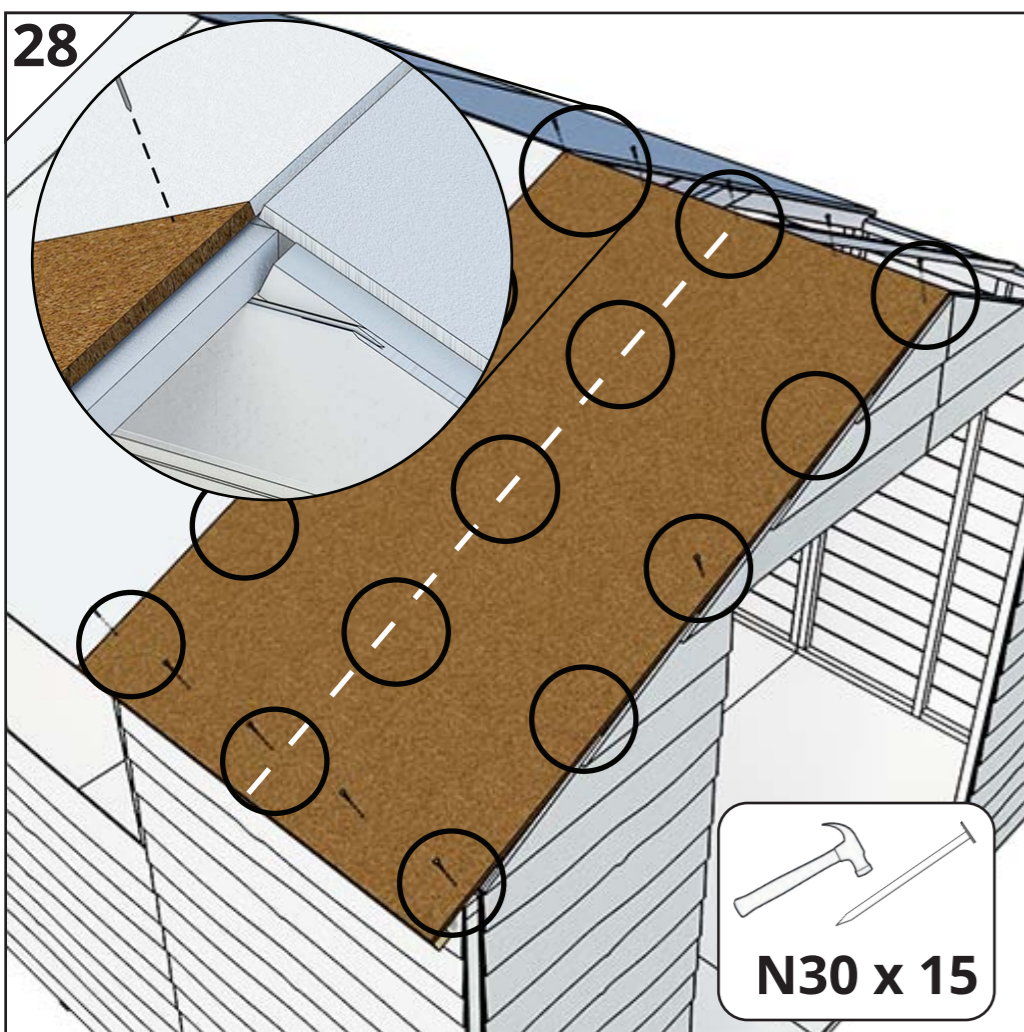
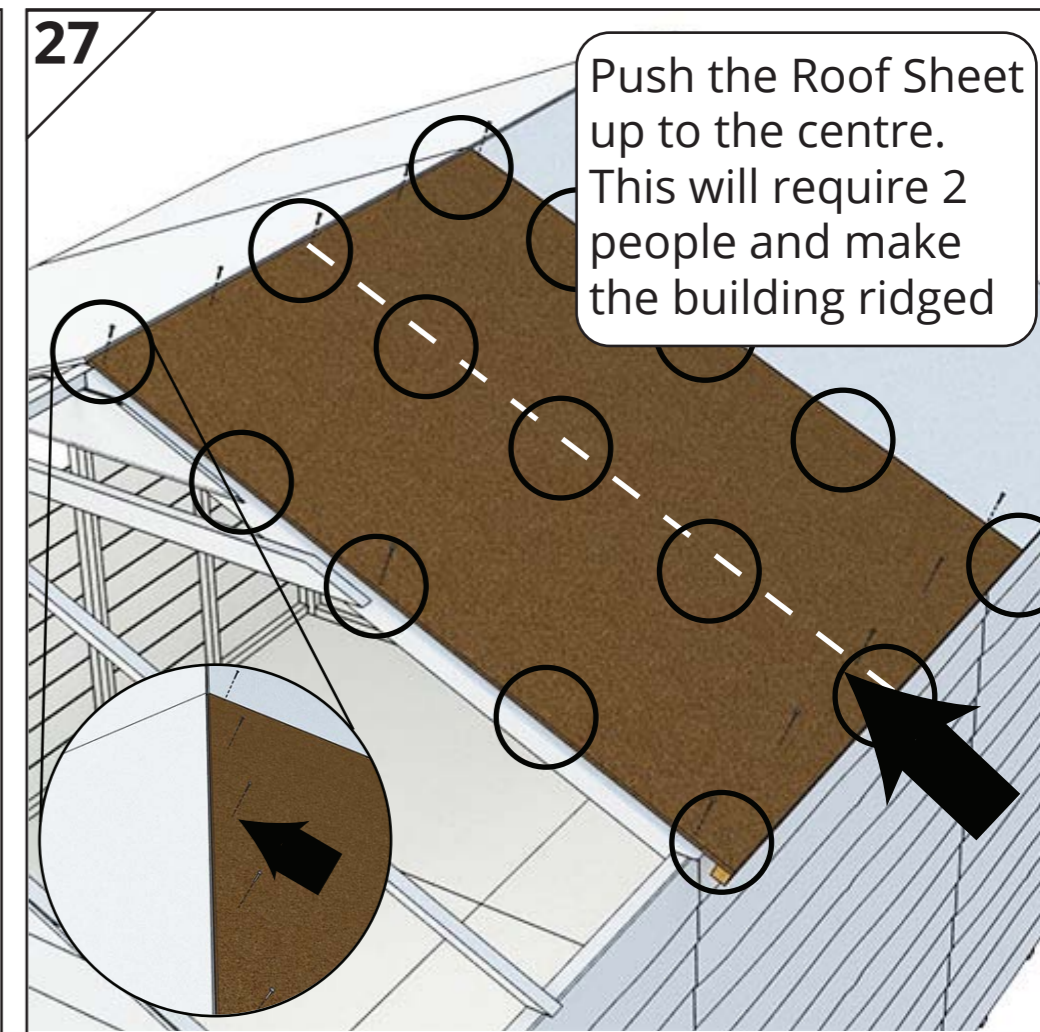
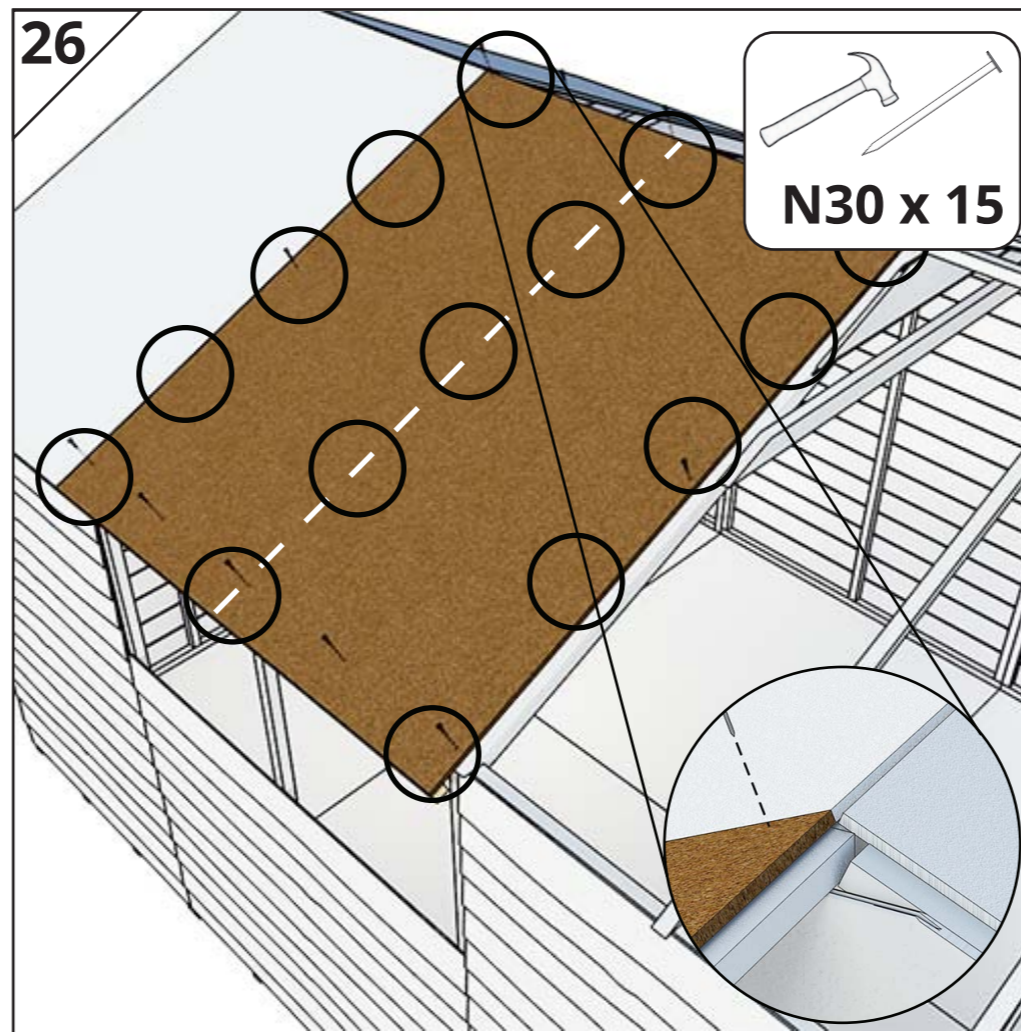
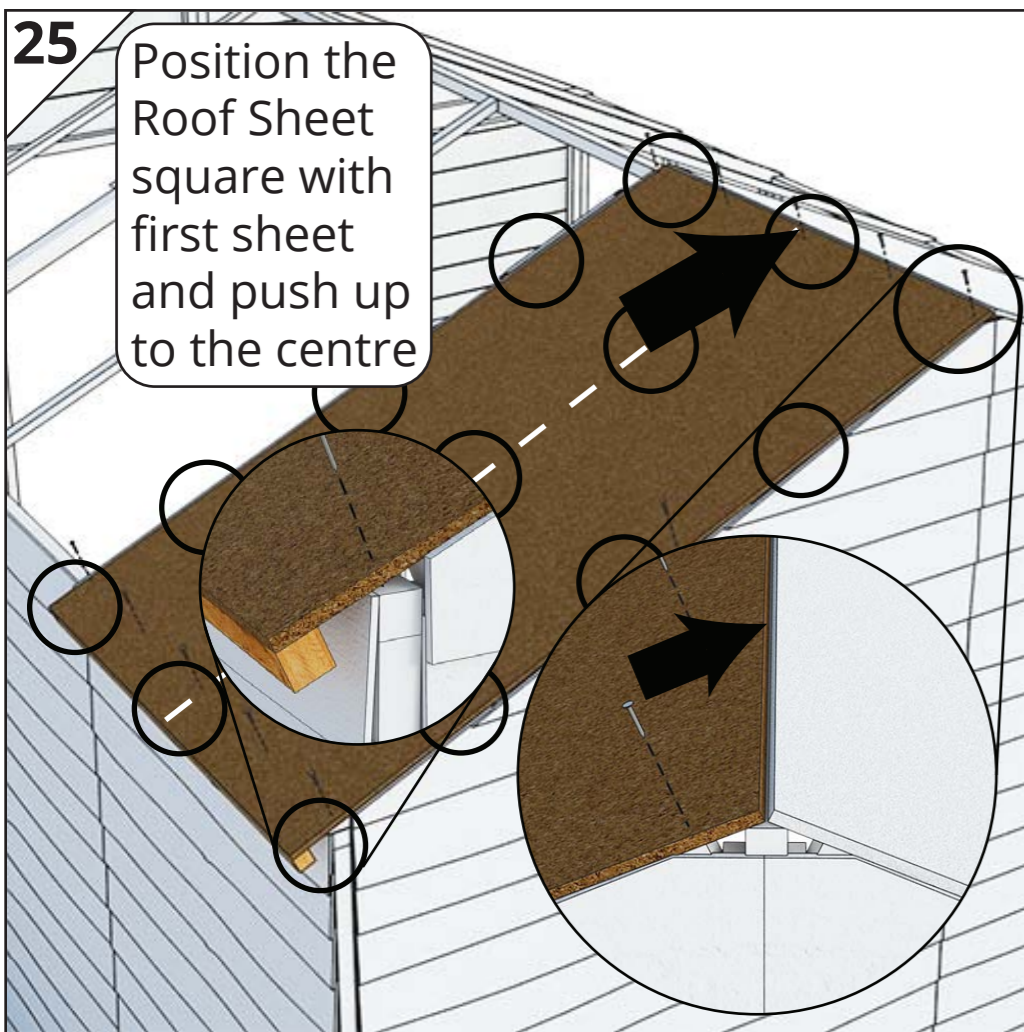

31

Line up the Door Threshold to the front of the Floor

S50 x 3 **1118mm DT x 1**
Requires cutting to size

32

Line up the Top Door Threshold to the back of the Gable framing

N30 x 4 **1118mm DT x 1**

33

Screw the Wall Panels to the floor

S50

34 **Door Fixing Stage**

Hinges fix to these Battons

Back View of Doors

35

CSP x 1
1740mm

S30 x 3

36

x 4

S25 x 16

37

2mm Gap

5mm Gap

x 1

S25 x 13

38

Top

S30 x 4

S25 x 2

Bottom

x 2
100mm

x 2

39 **Window Fixing Stage**

x 1

x 1

40

Do not nail through the Glazing

532mm

x 1

N30 x 3

41

Do not nail through the Glazing

N30 x 6

532mm **x 2**

x 1 **x 1**

42 **Cloaking Strip Fixing Stage**

Cut to size

Cut to size (Windowed Building Only)

N30

532mm **CSW**

1500mm **CSP**

43

Cut to size

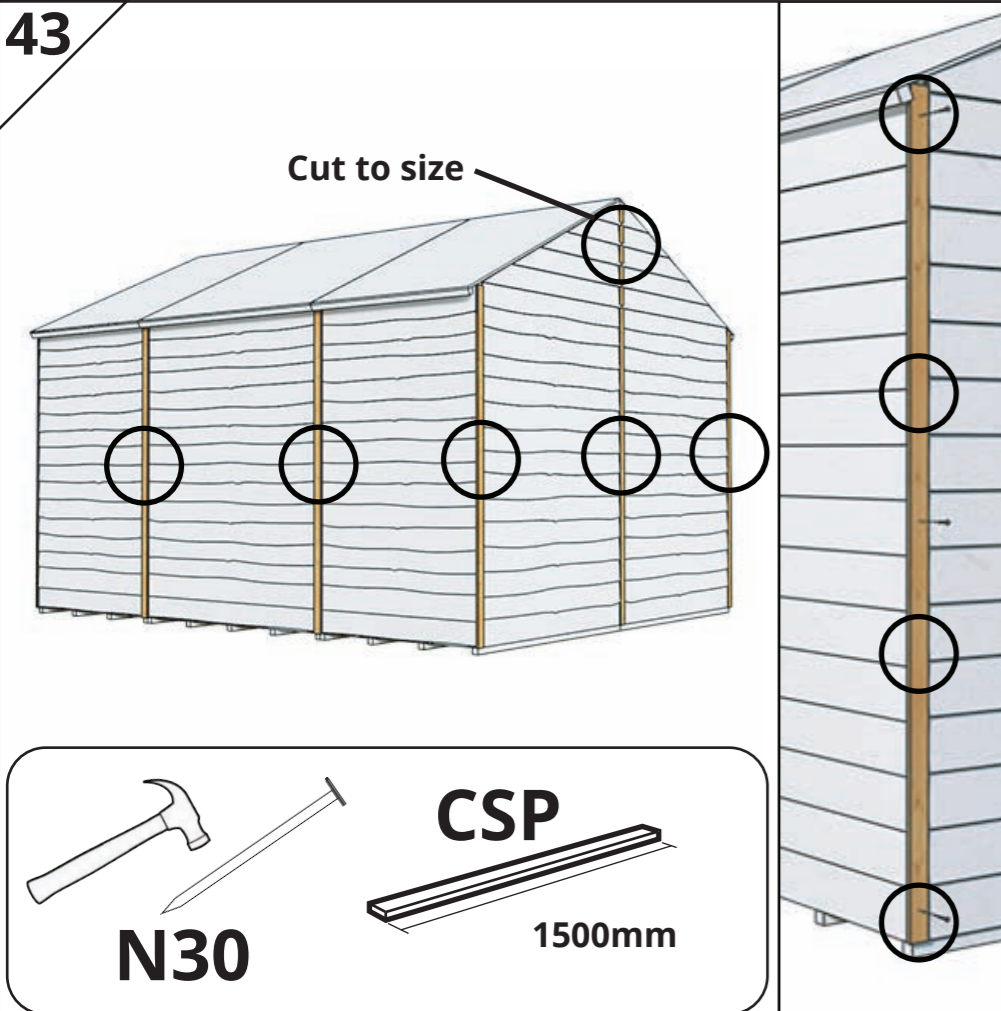

N30 **CSP** 1500mm

This panel shows a perspective view of a shed roof with vertical battens. A callout shows a close-up of a batten being secured with a nail. Below the main diagram, there is a list of tools and materials: a hammer, a nail labeled 'N30', and a wooden batten labeled 'CSP' with a length of '1500mm'.

44 **Felt Fixing Stage**

x 3

Length of roof + 140mm

Felt

Felt

Front View
(8ft Gables)
(3 PIECES OF FELT)

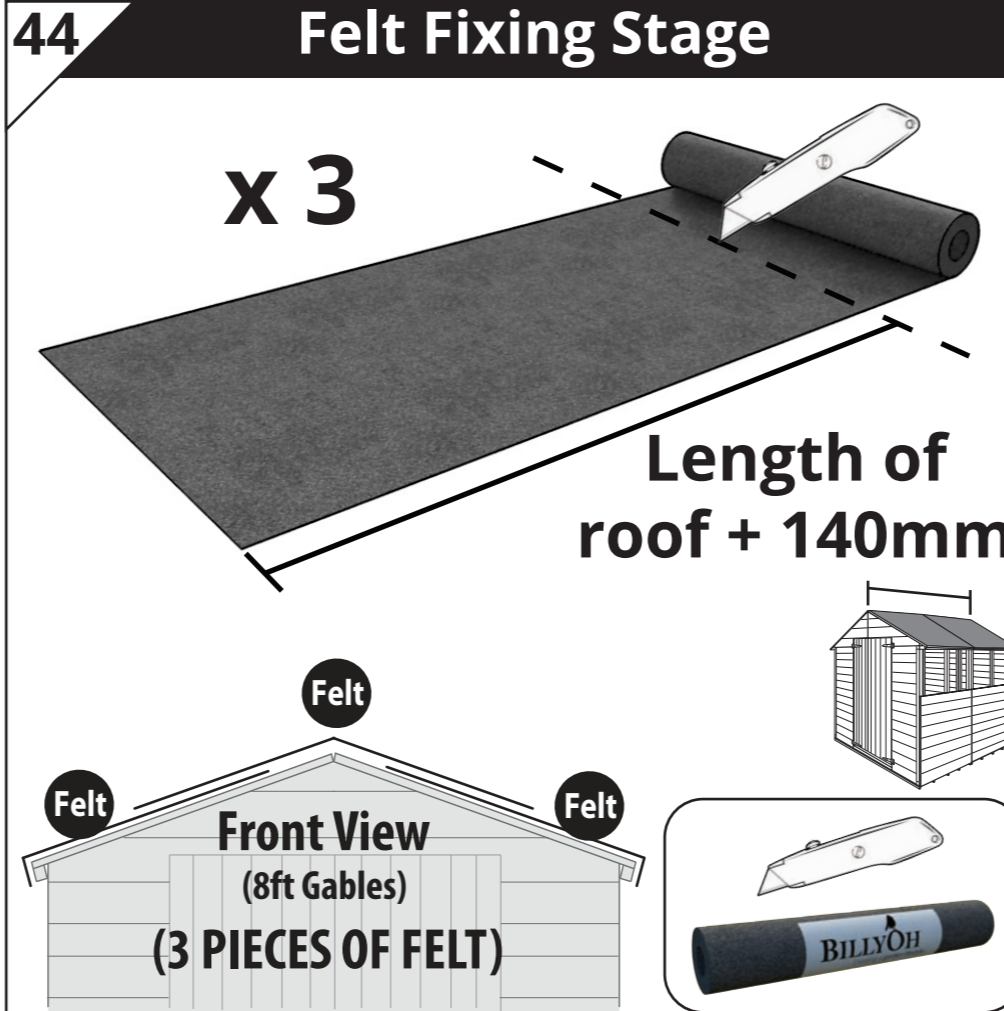

This panel illustrates the 'Felt Fixing Stage'. It shows three pieces of felt being cut to the 'Length of roof + 140mm'. A front view of the shed roof shows three pieces of felt being applied to the gables. Tools shown include a utility knife and a roll of 'BILLYOH' brand felt.

45

70mm overhang at each end

Tack to hold in place

Fold over Eaves

T8

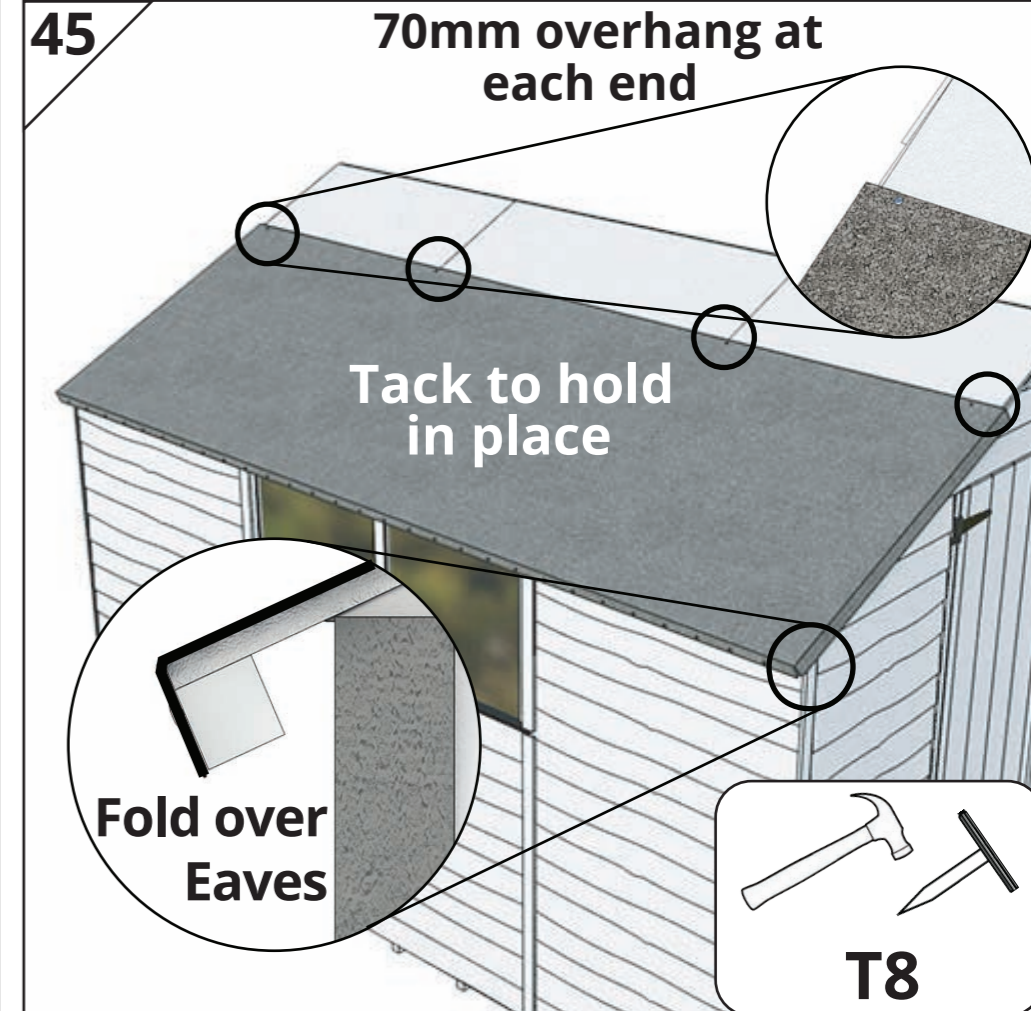

This panel shows the felt being tacked to the roof with a 70mm overhang at each end. A callout shows the felt being folded over the eaves. Tools shown include a hammer and a nail labeled 'T8'.

46

Fold over Corner

100mm

T8

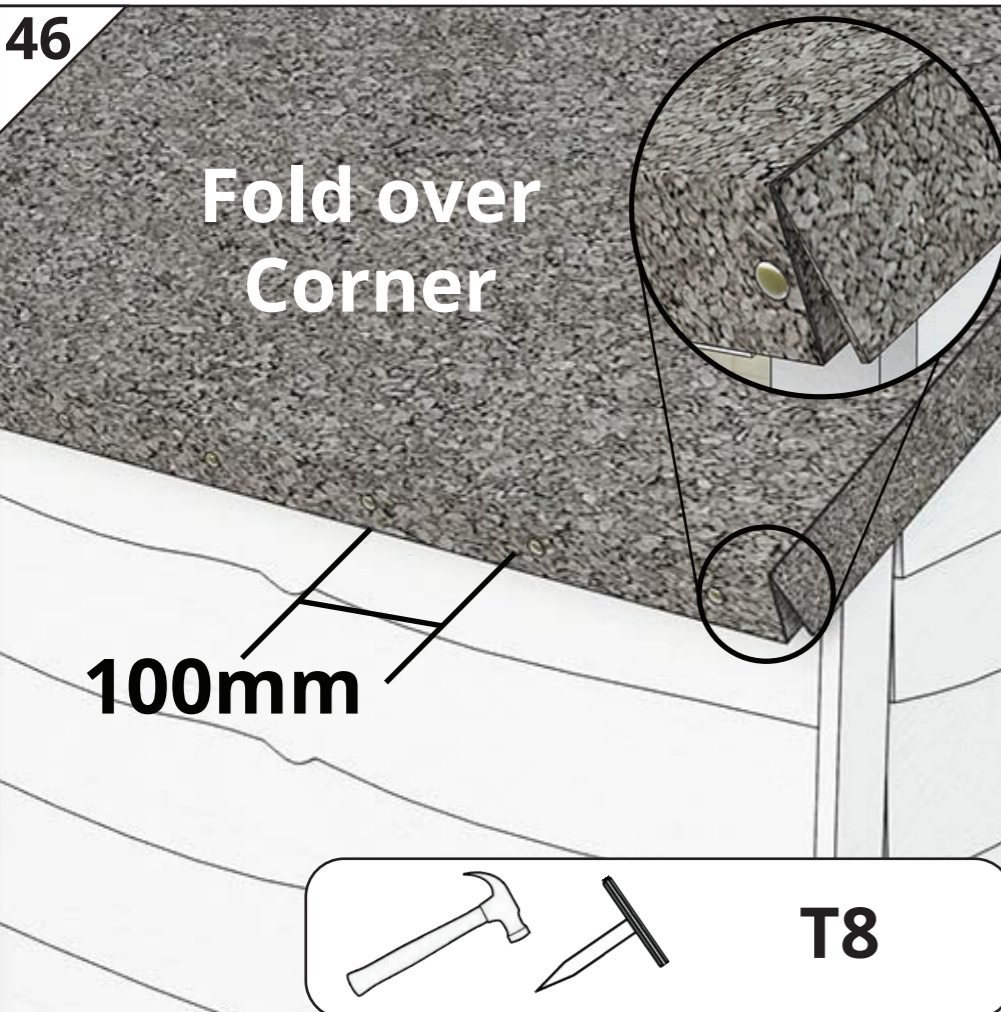

This panel shows the felt being folded over the corner of the roof with a 100mm overlap. A callout shows the felt being secured with a nail. Tools shown include a hammer and a nail labeled 'T8'.

47

T8

Repeat previous stages for this side

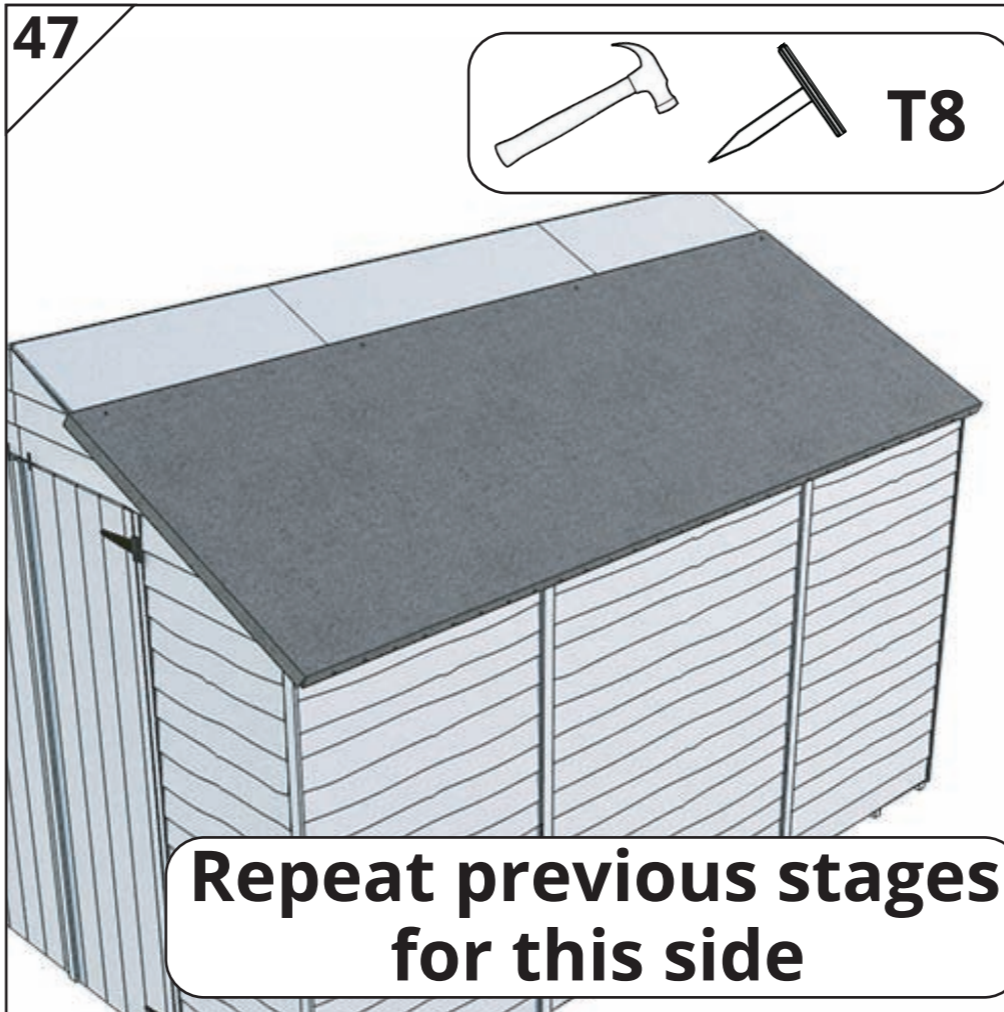

This panel shows the shed roof with felt applied to both sides. A callout shows the felt being secured with a nail. Tools shown include a hammer and a nail labeled 'T8'.

48

T8

100mm

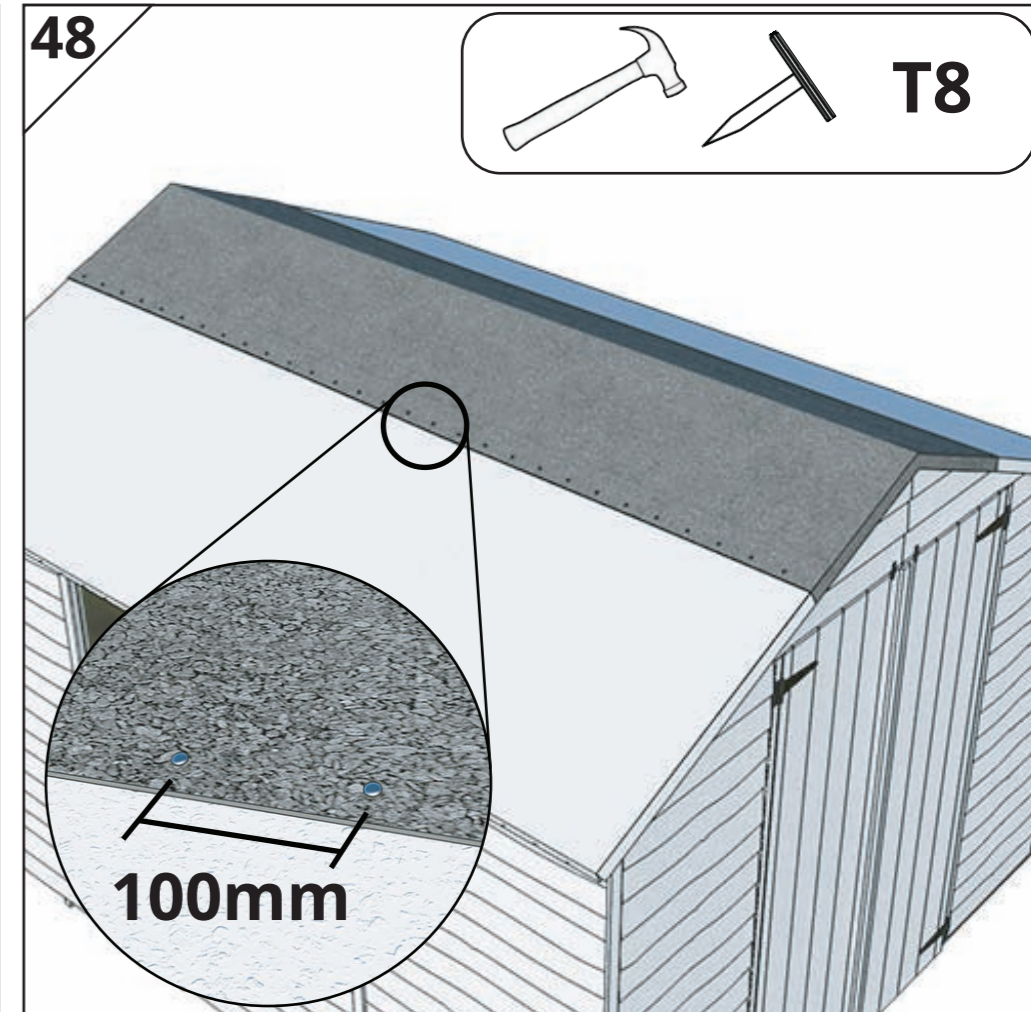

This panel shows the felt being secured with nails along the roof edge. A callout shows the felt being secured with a nail. Tools shown include a hammer and a nail labeled 'T8'.

49 **Facia Fixing Stage**

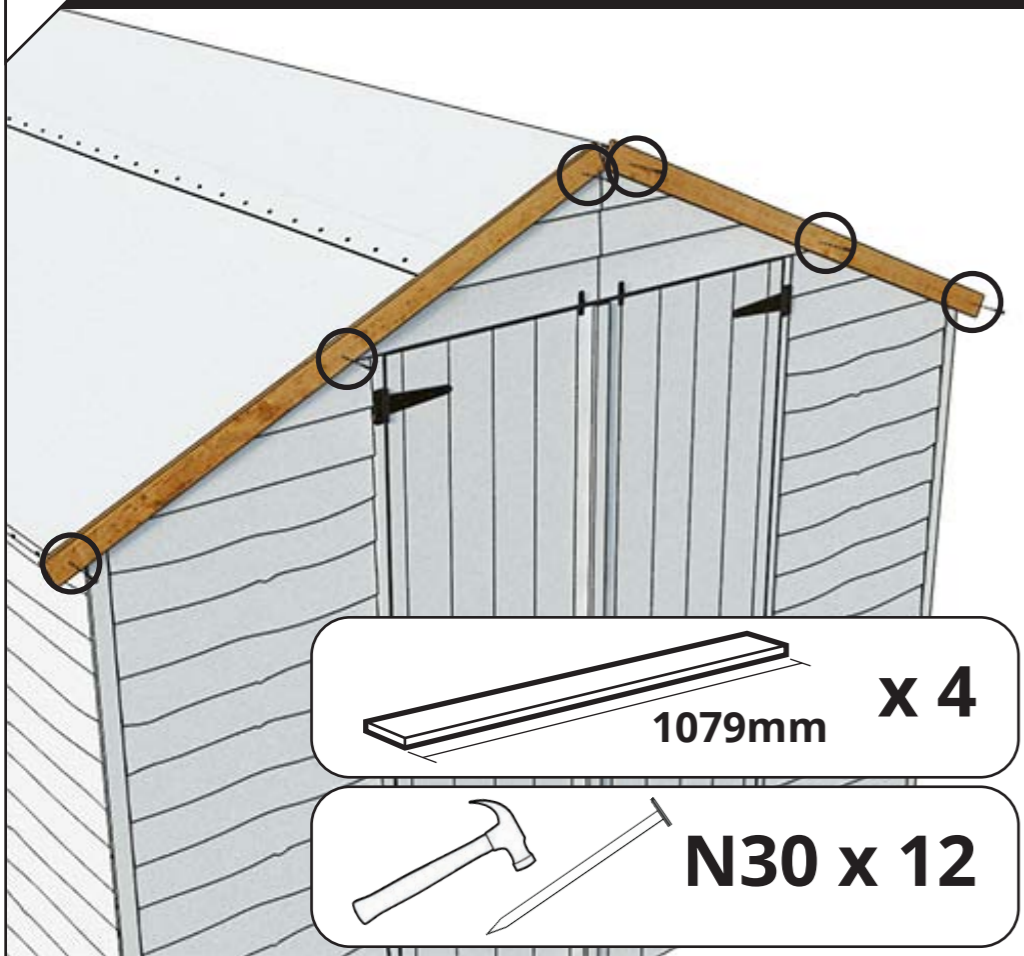

1079mm x 4

N30 x 12

50 **Pilot drill holes first**

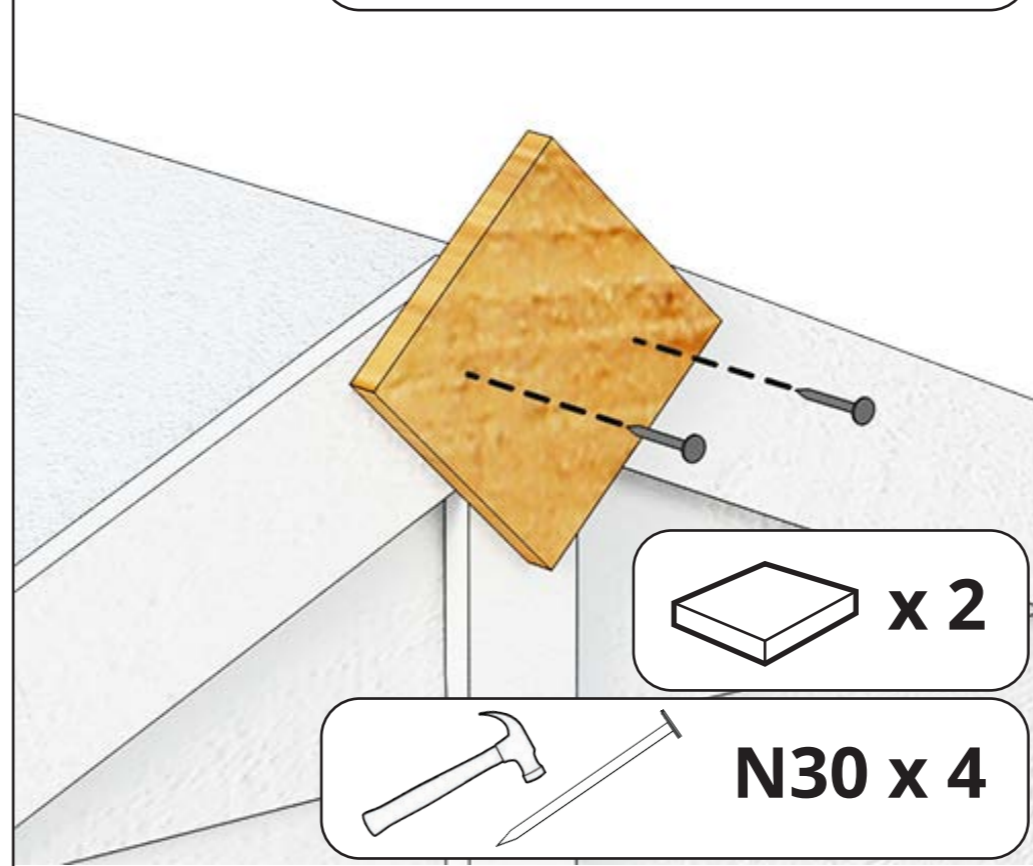

x 2

N30 x 4

51 **Protect your building**



Treat after assembly and annually to protect

52 **Protect your building**



Treat after assembly and annually to protect

53 **Protect your building**



Treat after assembly and annually to protect

54 **Protect your building**



Treat after assembly and annually to protect