

BillyOh 8ft Gable
Master Tongue & Groove
Apex Range[©]
Windowed / Windowless
Technical Details



For Queries and Help
please call Product
Support:
01636 858377

PROPRIETARY AND CONFIDENTIALITY

All the information contained within this document including all technical data, dimensions, shape/form and branding (inc. Trademarks, logos, etc.) Is the sole property of Kybotech Limited. The reproduction and/or disclosure to any third party of any information contained within this document is strictly prohibited. Breaches of the copyright will be dealt with on the highest level of severity with immediate legal proceedings.

8ft Gable Windowed/Windowless Tongue & Groove Shed (Double Door Range) Front elevation: width 2.598m/8' 6"

Sizes available

available in standard 7mm cladding types

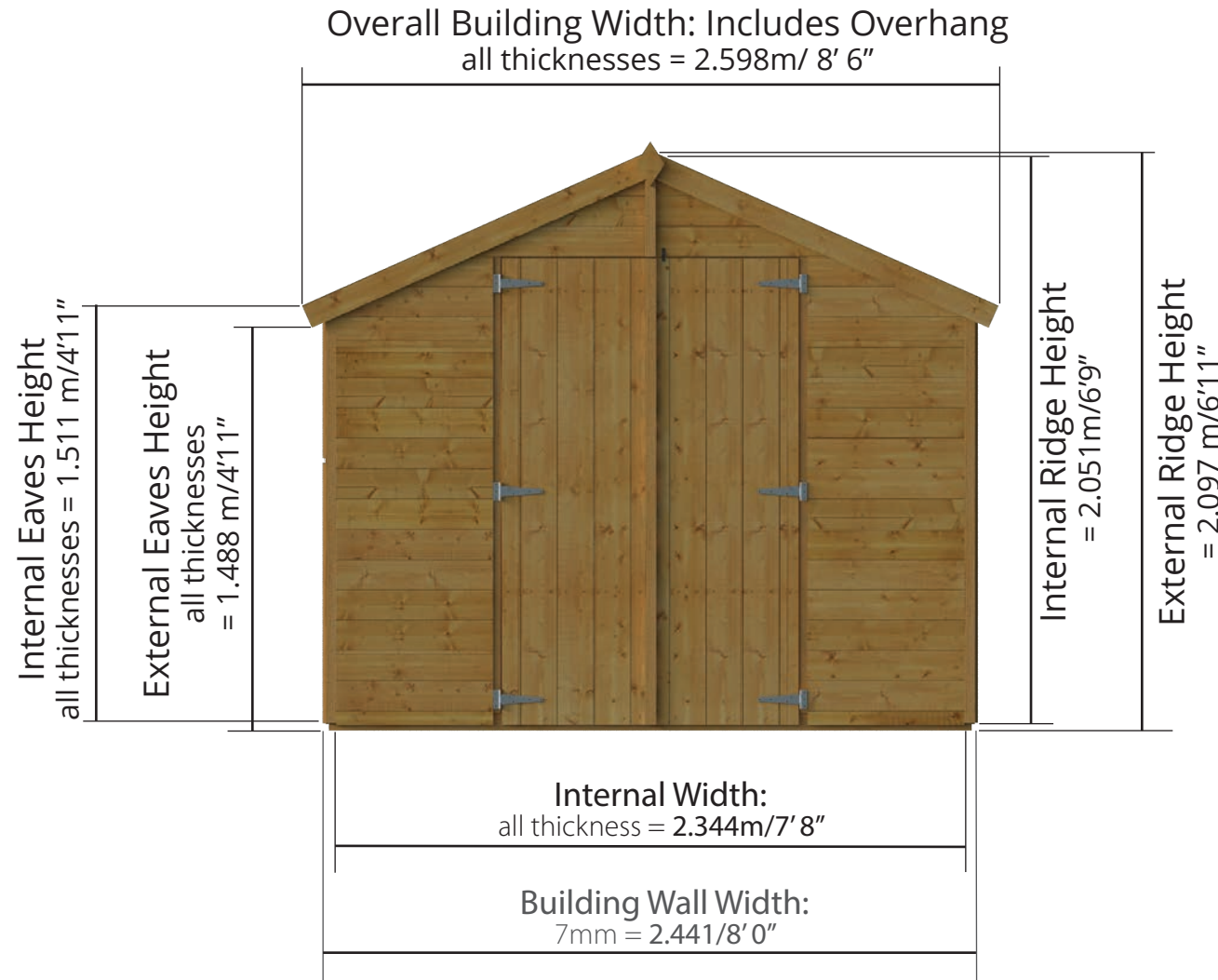

Windowed / Windowless
D12ft x W8ft
(Including Overhang)



Windowed / Windowless
D16ft x W8ft
(Including Overhang)



Windowed / Windowless
D8ft x W8ft
(Including Overhang)



Windowed / Windowless
D10ft x W8ft
(Including Overhang)

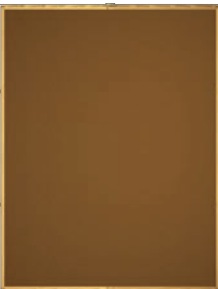

Windowed / Windowless
D4ft x W8ft
(Including Overhang)



D4.754m x W2.598m / D16' 7" x W8' 6"

Windowed Tongue & Groove Apex Shed:

Side elevation

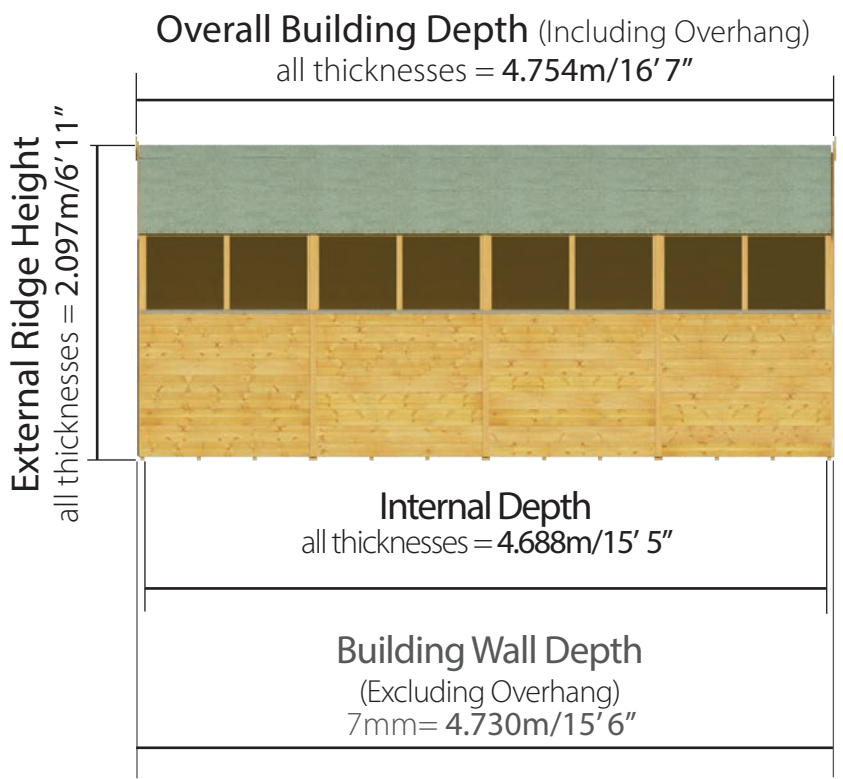

Side of Building

Floor Plan

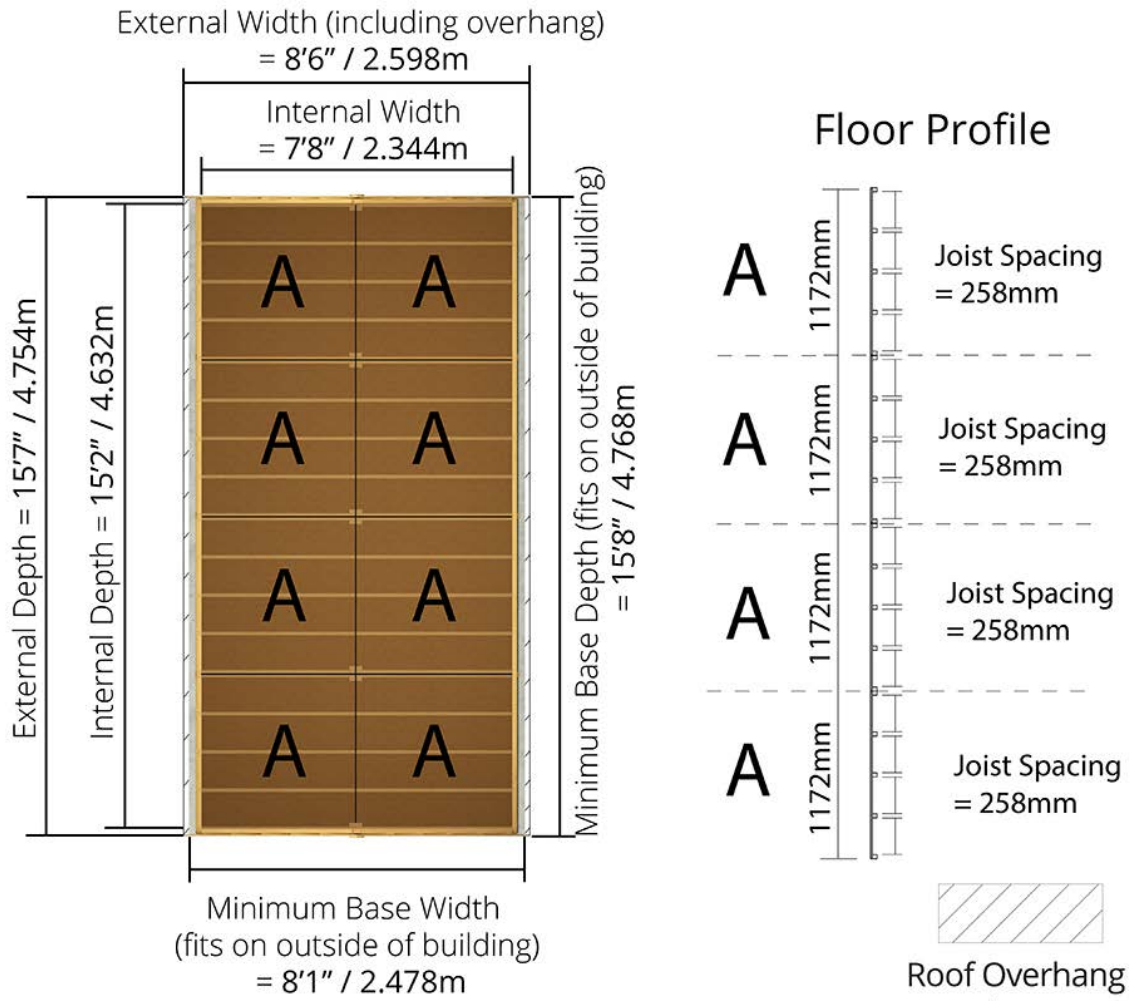

Front of Building

Please note: your base must be perfectly level and drainage is required to allow water to run off the surface. There must also be at least 2m clearance on each side to allow annual treatment to be applied.

D4.754m x W2.598m / D16' 7" x W8' 6"

Windowless Tongue & Groove Apex Shed:

Side elevation

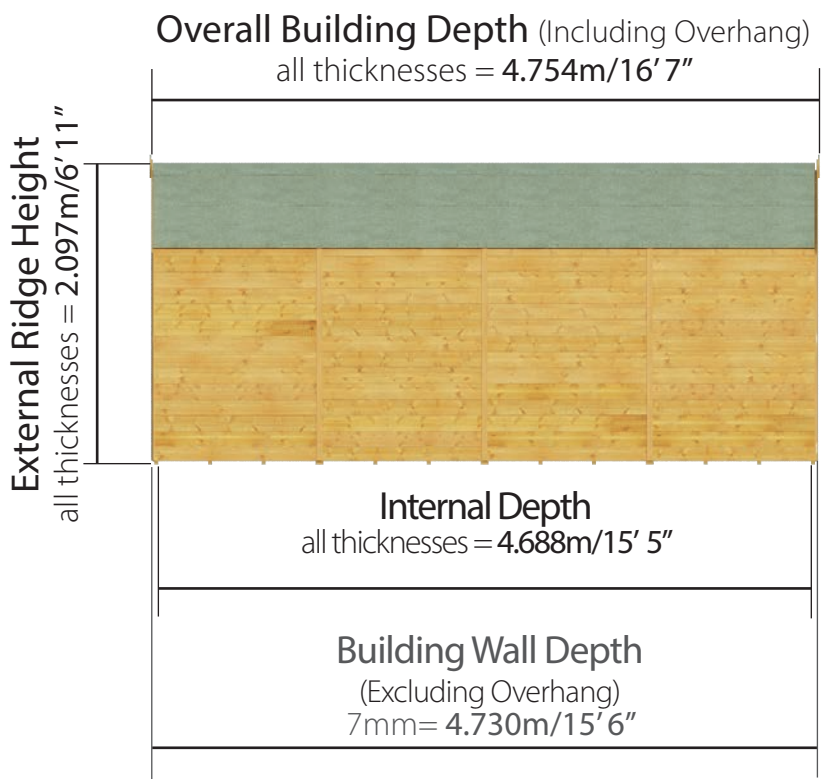

Side of Building

Floor Plan

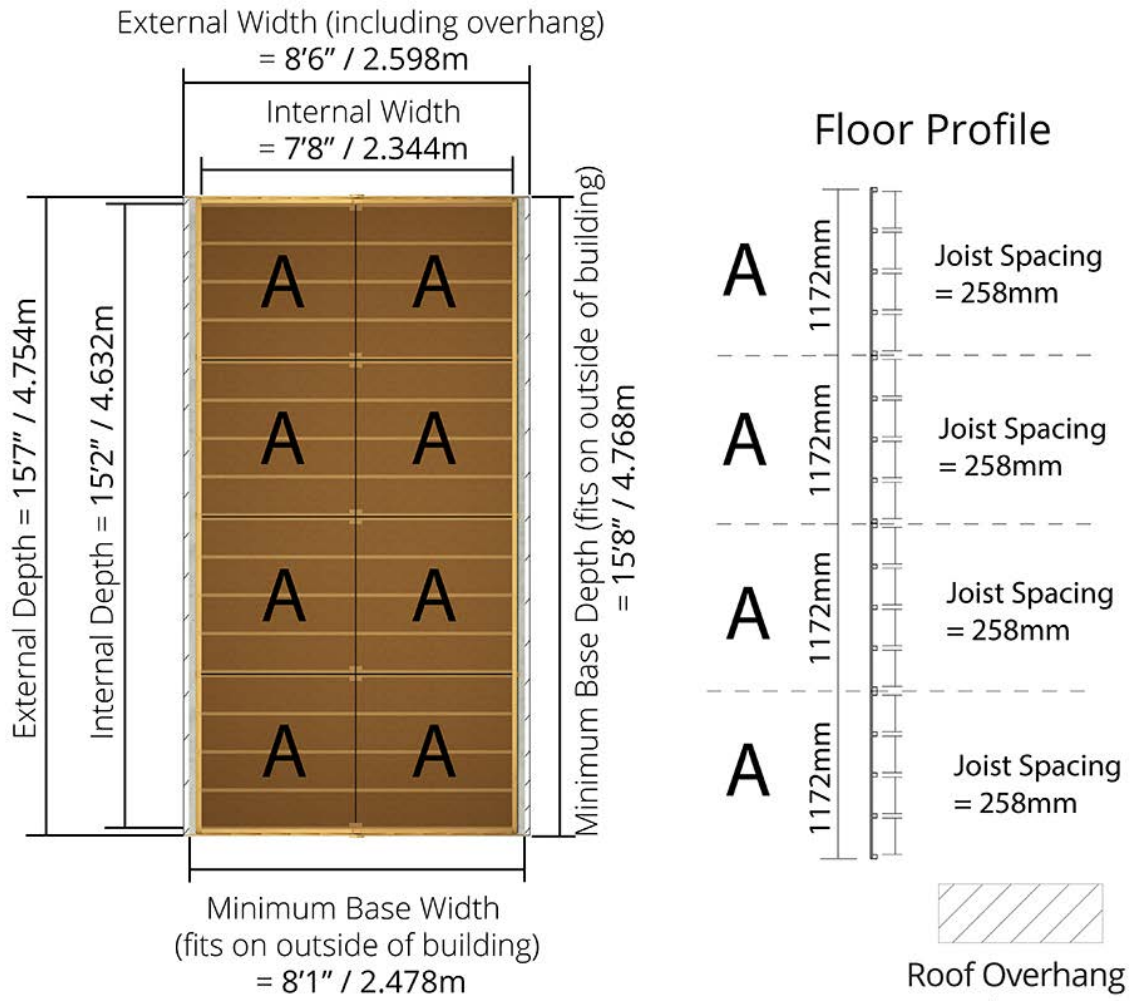

Front of Building

Please note: your base must be perfectly level and drainage is required to allow water to run off the surface. There must also be at least 2m clearance on each side to allow annual treatment to be applied.

D4.754m x W2.598m / D11' 9" x W8' 6"

Windowed Tongue & Groove Apex Shed:

Side elevation

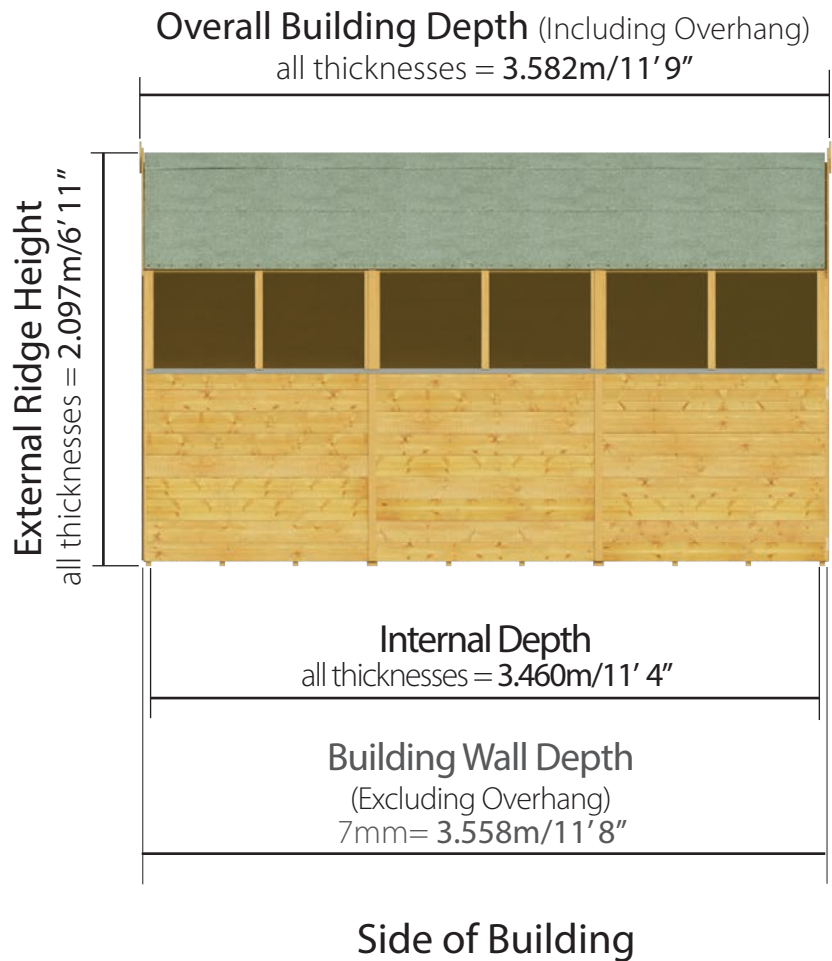

Floor Plan

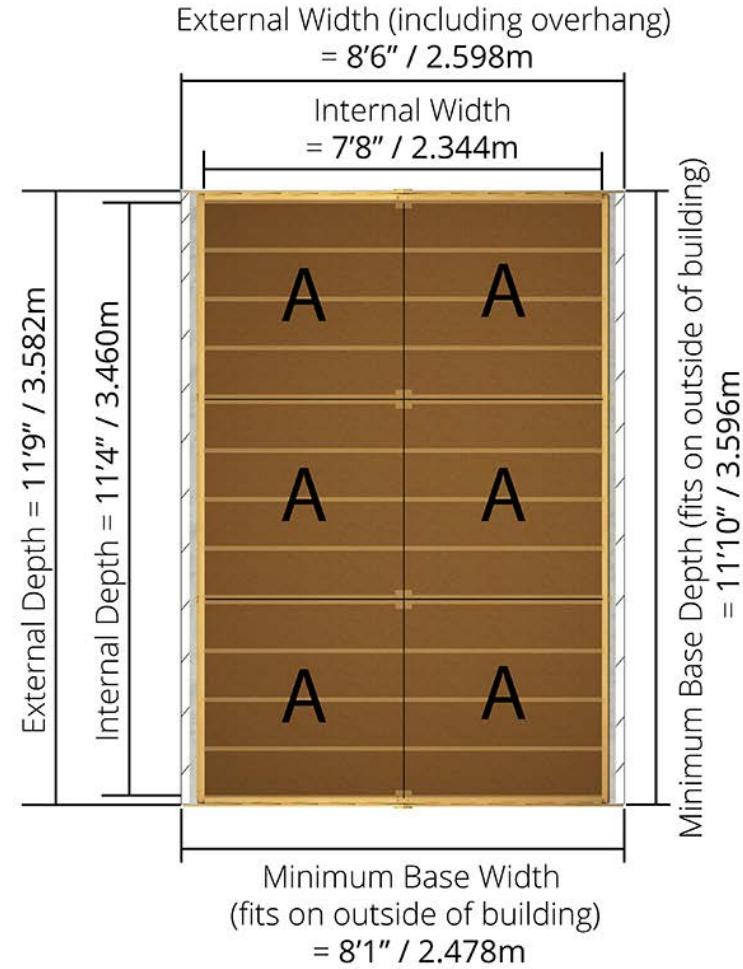

Floor Profile

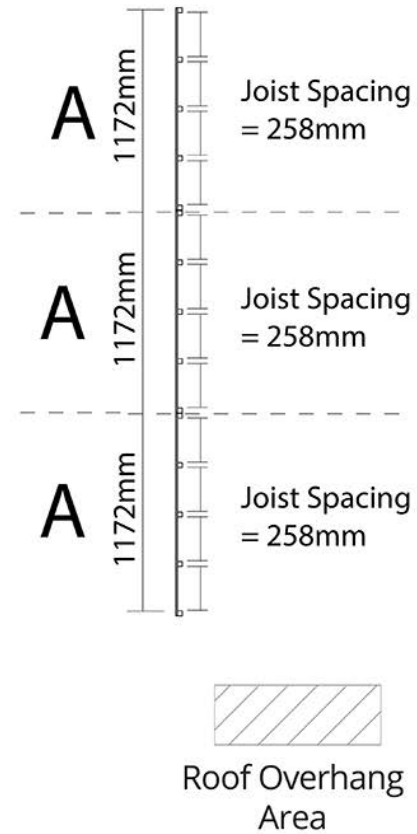

Please note: your base must be perfectly level and drainage is required to allow water to run off the surface. There must also be at least 2m clearance on each side to allow annual treatment to be applied.

D4.754m x W2.598m / D11' 9" x W8' 6"

Windowless Tongue & Groove Apex Shed:

Side elevation

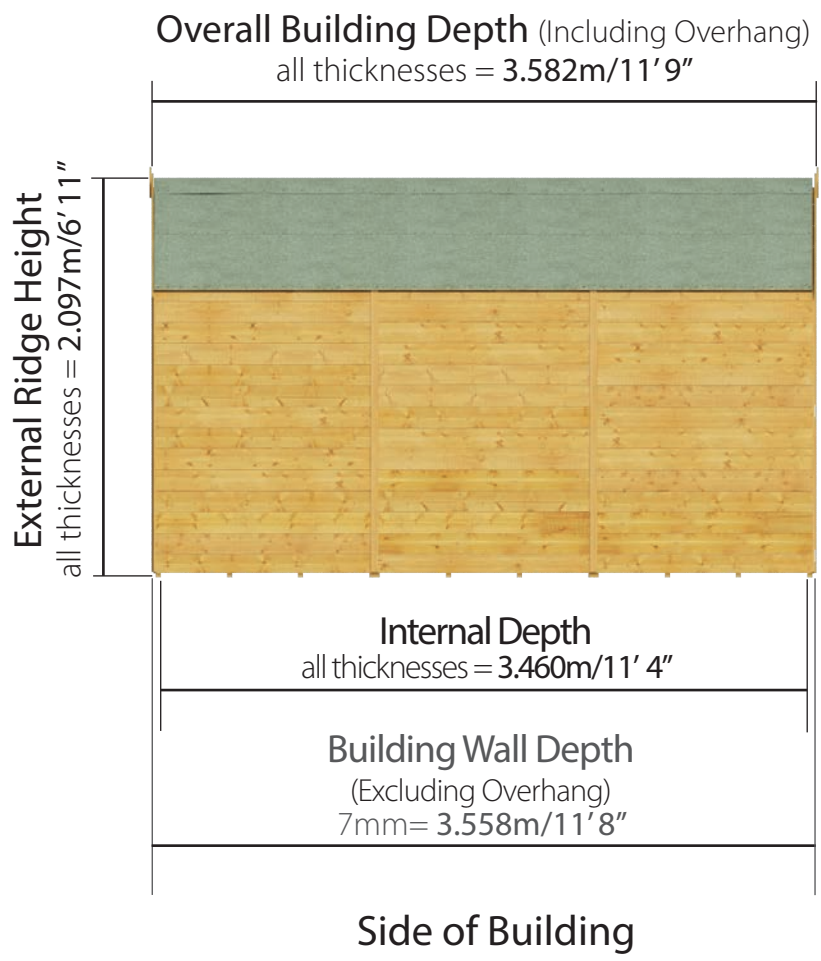

Floor Plan

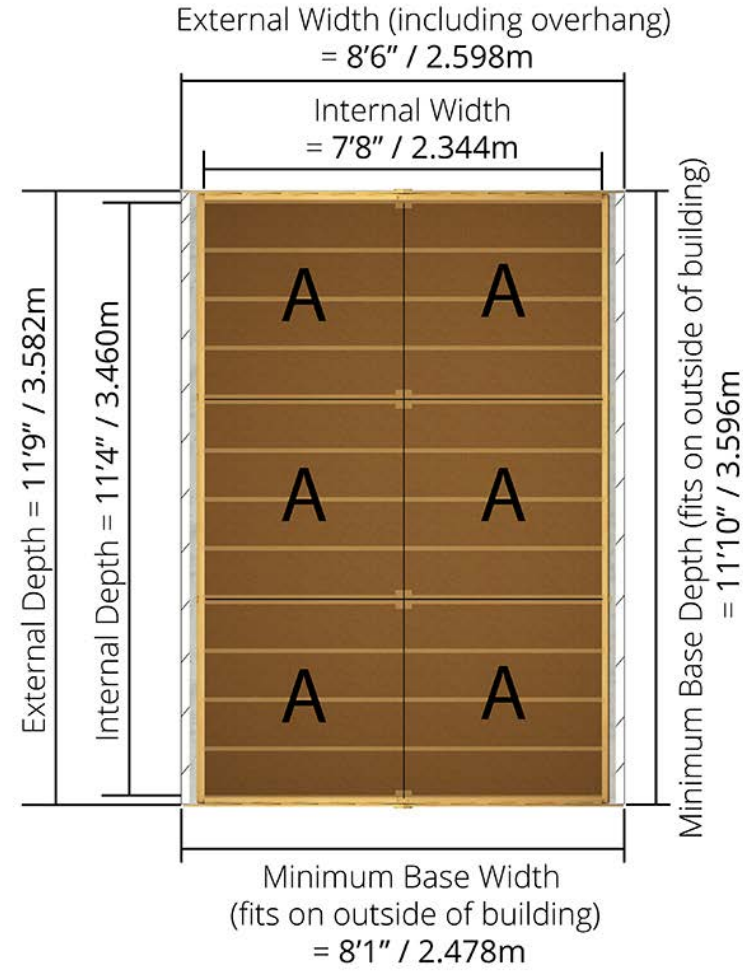

Floor Profile

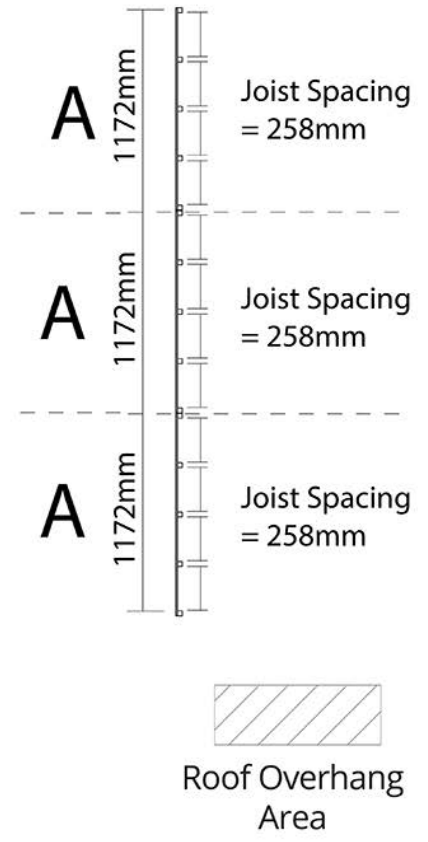

Please note: your base must be perfectly level and drainage is required to allow water to run off the surface. There must also be at least 2m clearance on each side to allow annual treatment to be applied.

D2.996m x W2.598m / D9' 10" x W8' 6"

Windowed Tongue & Groove Apex Shed:

Side elevation

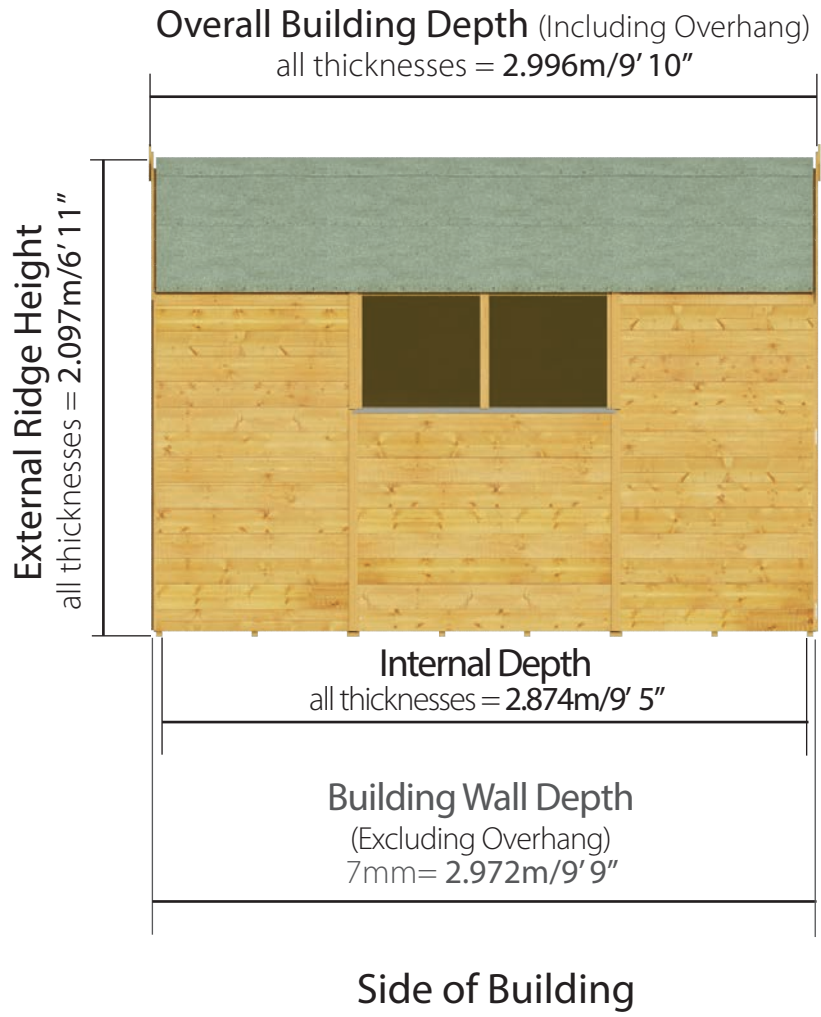

Floor Plan

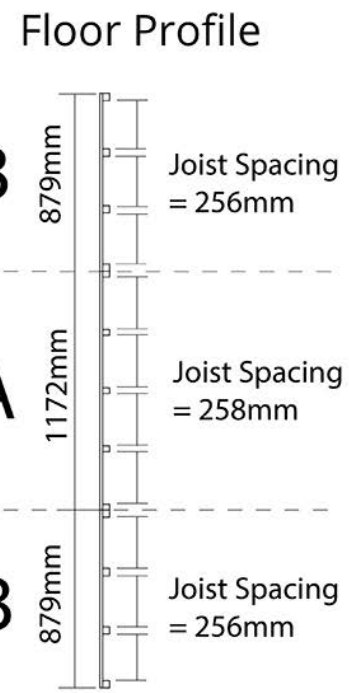
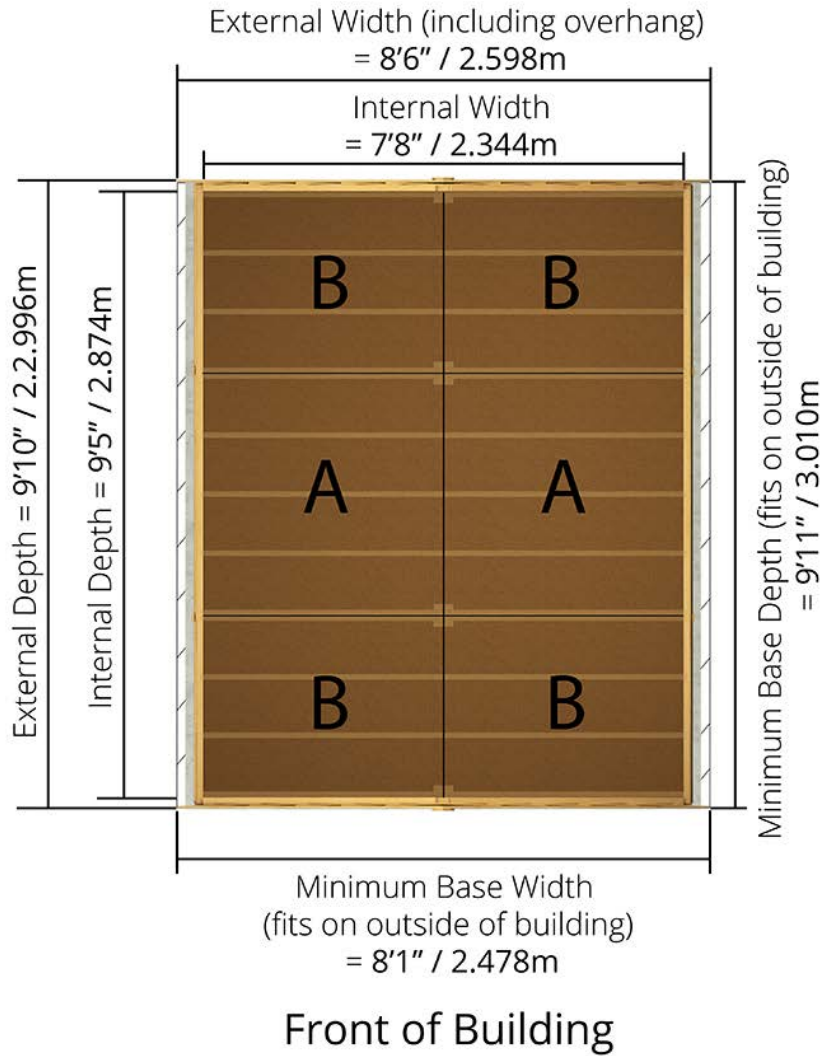

Please note: your base must be perfectly level and drainage is required to allow water to run off the surface. There must also be at least 2m clearance on each side to allow annual treatment to be applied.

D2.996m x W2.598m / D9' 10" x W8' 6"

Windowless Tongue & Groove Apex Shed:

Side elevation

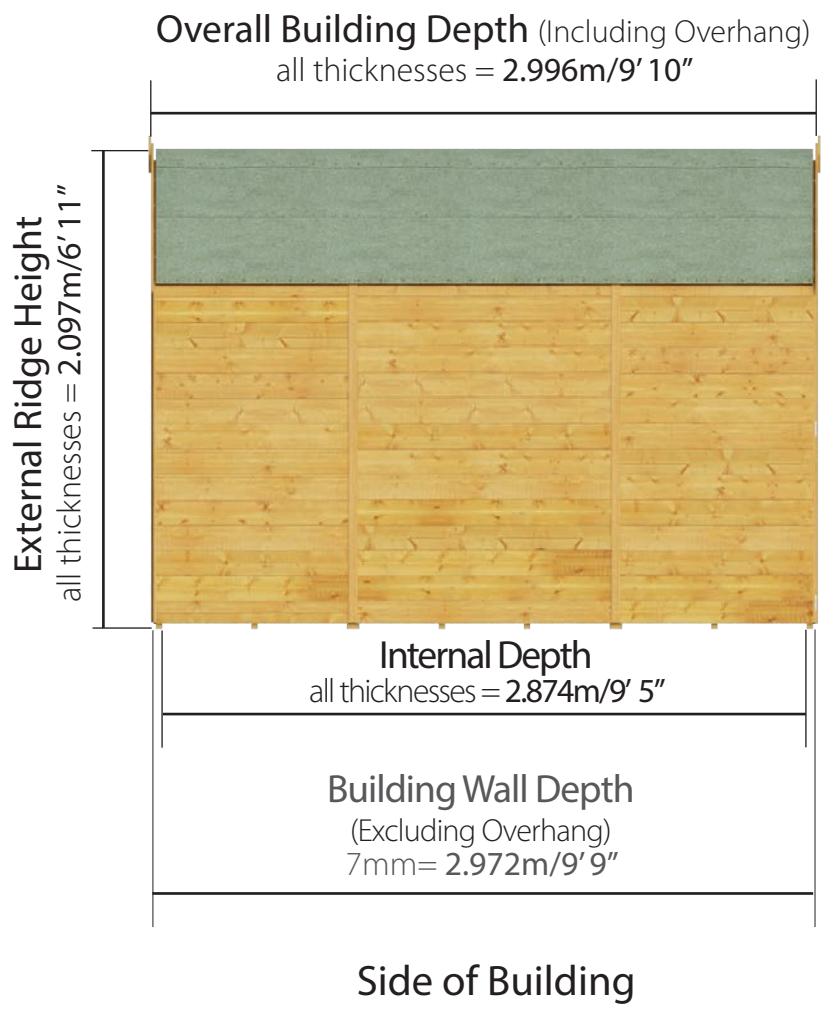

Floor Plan

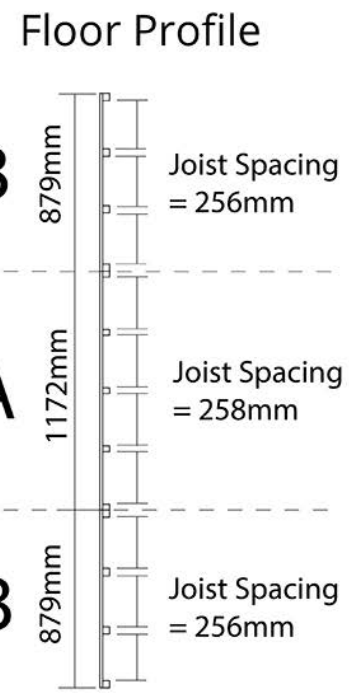
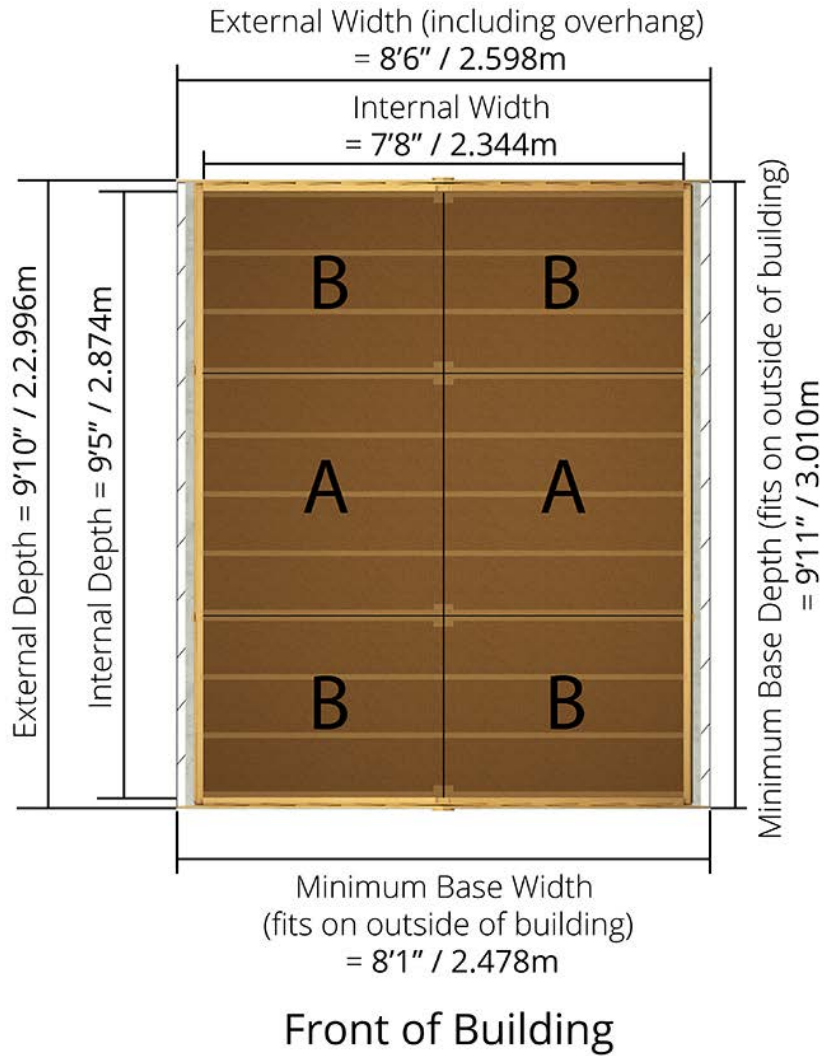

Please note: your base must be perfectly level and drainage is required to allow water to run off the surface. There must also be at least 2m clearance on each side to allow annual treatment to be applied.

D2.410m x W2.598m / D7' 11" x W8' 6"

Windowed Tongue & Groove Apex Shed:

Side elevation

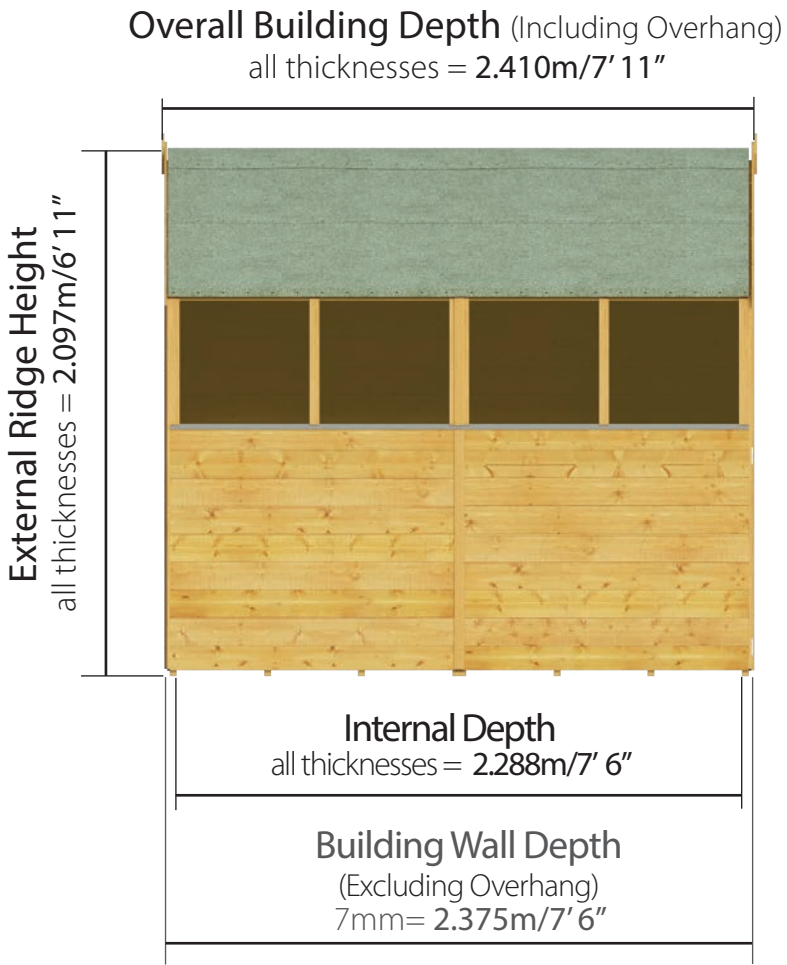

Side of Building

Floor Plan

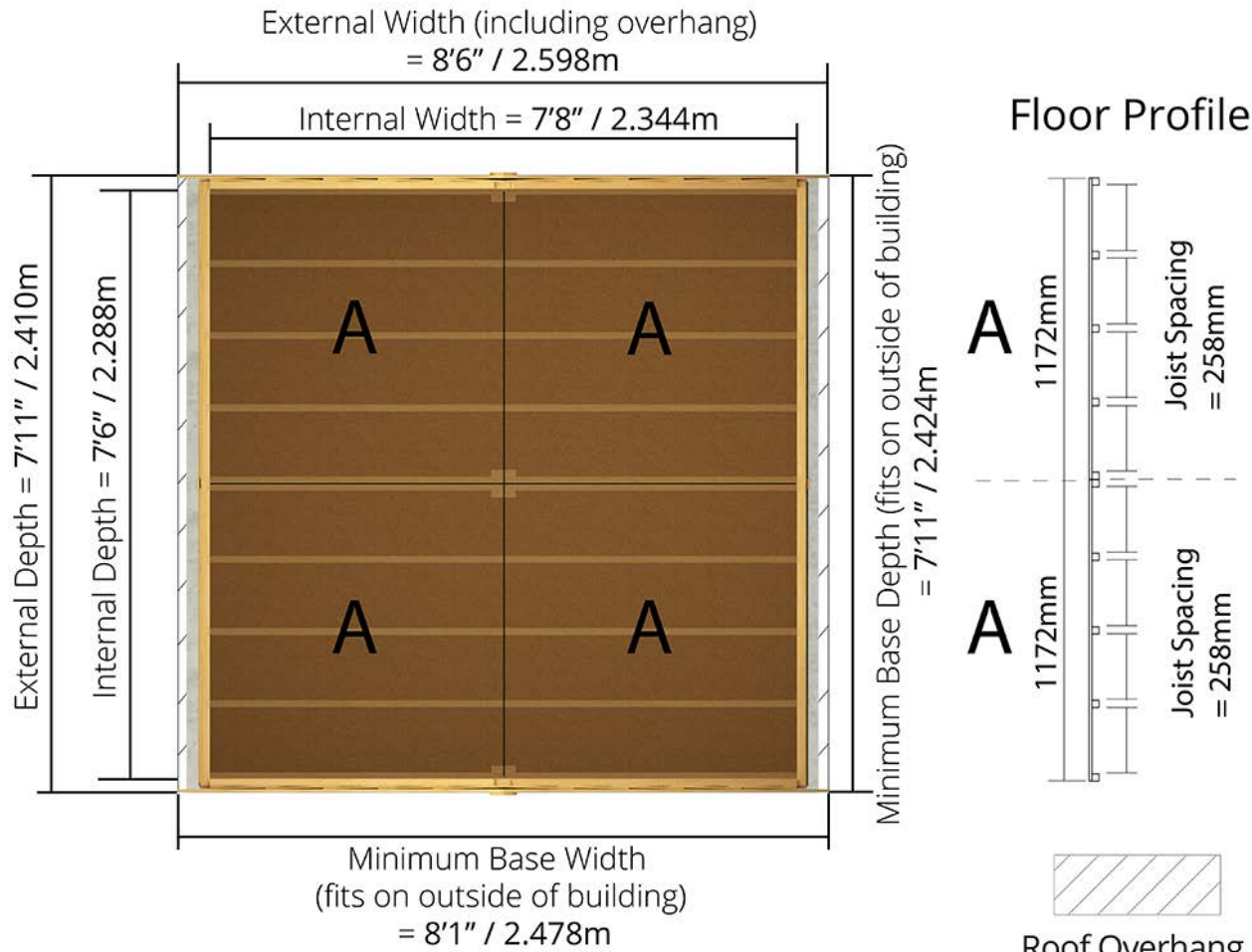

Front of Building

Please note: your base must be perfectly level and drainage is required to allow water to run off the surface. There must also be at least 2m clearance on each side to allow annual treatment to be applied.

D2.410m x W2.598m / D7' 11" x W8' 6"

Windowless Tongue & Groove Apex Shed:

Side elevation

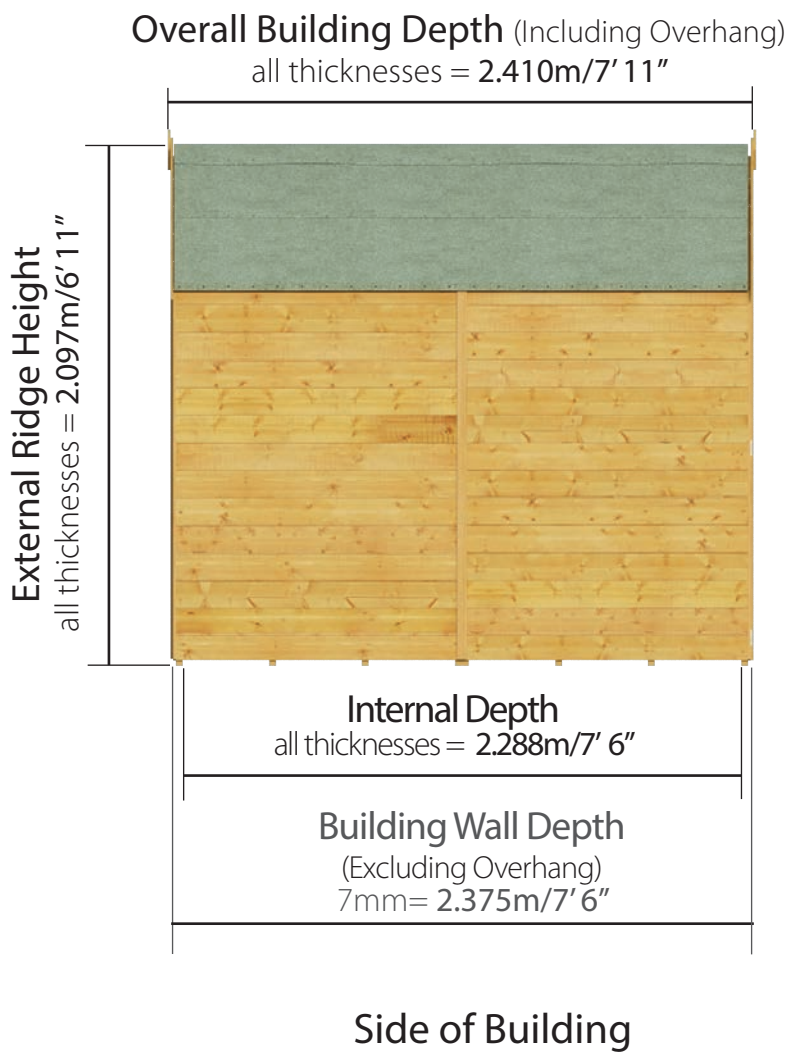

Floor Plan

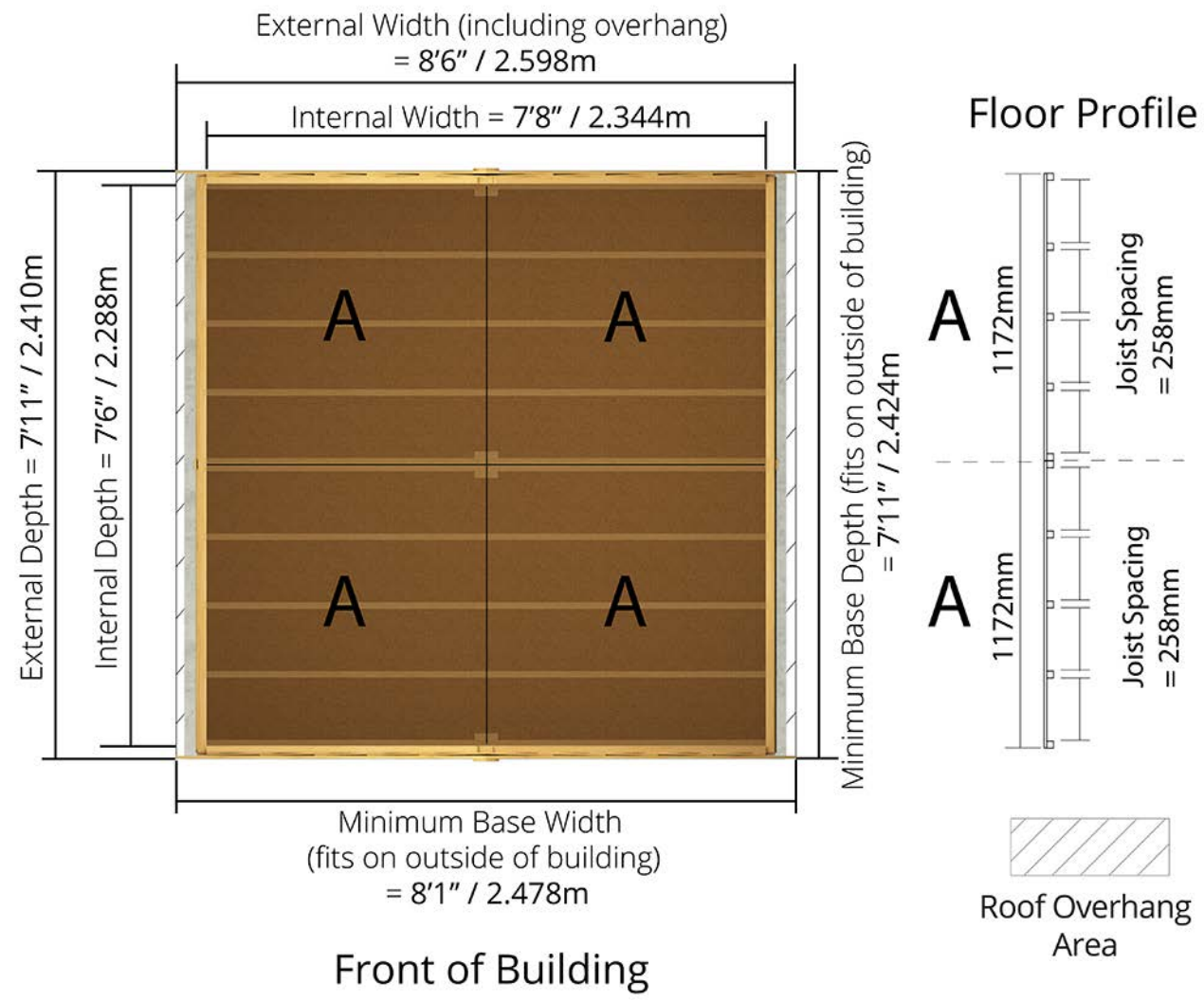

Please note: your base must be perfectly level and drainage is required to allow water to run off the surface. There must also be at least 2m clearance on each side to allow annual treatment to be applied.

D1.238m x W2.598m / D4' 1" x W8' 6"

Windowed Tongue & Groove Apex Shed:

Side elevation

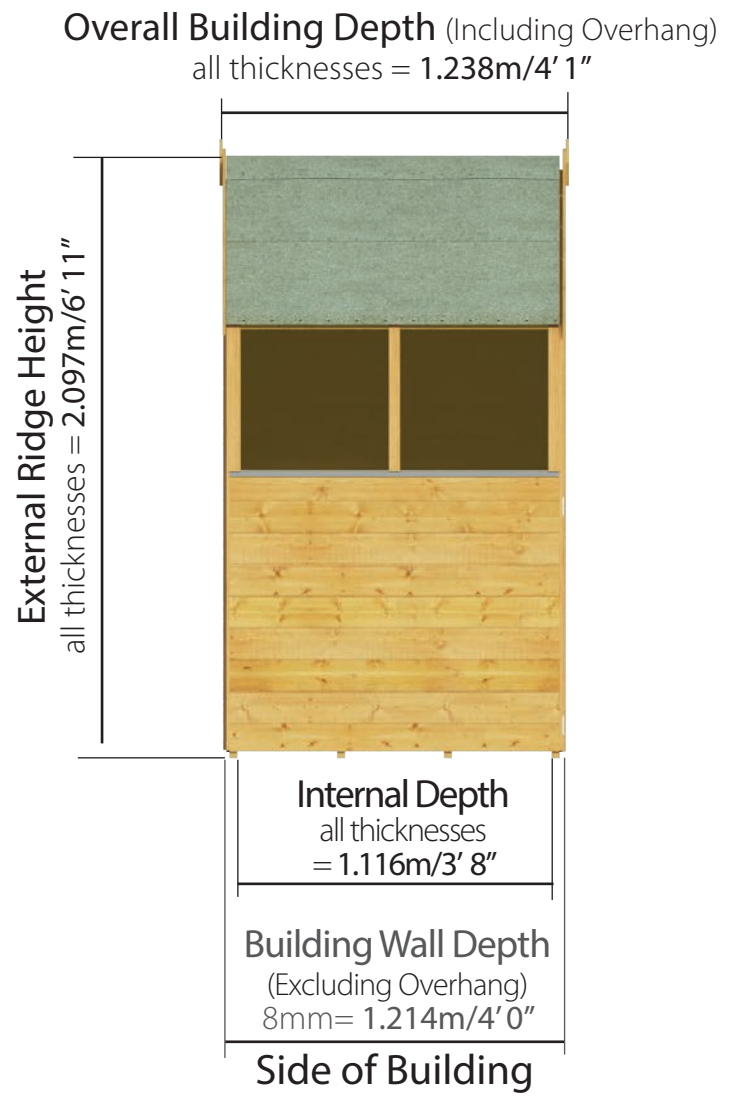

Floor Plan

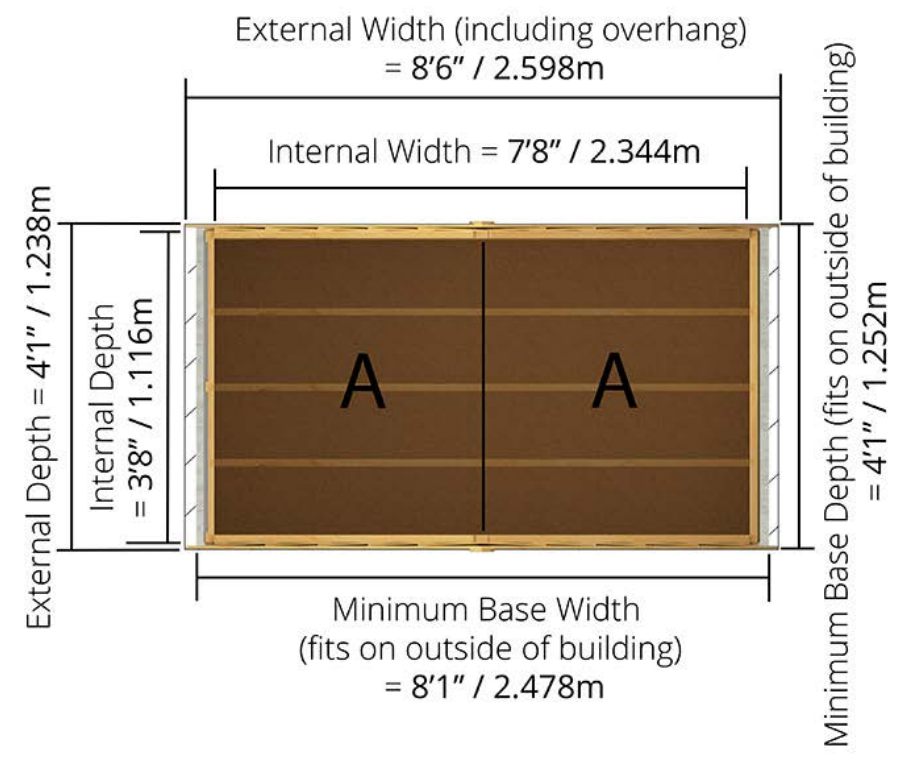

Floor Profile

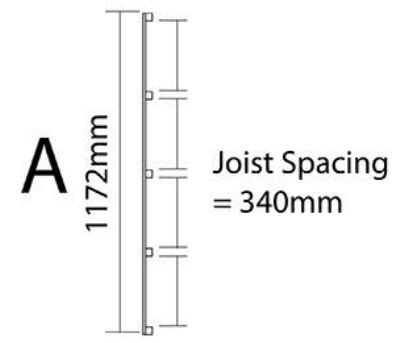

Roof Overhang Area

Please note: your base must be perfectly level and drainage is required to allow water to run off the surface. There must also be at least 2m clearance on each side to allow annual treatment to be applied.

D1.238m x W2.598m / D4' 1" x W8' 6"

Windowless Tongue & Groove Apex Shed:

Side elevation

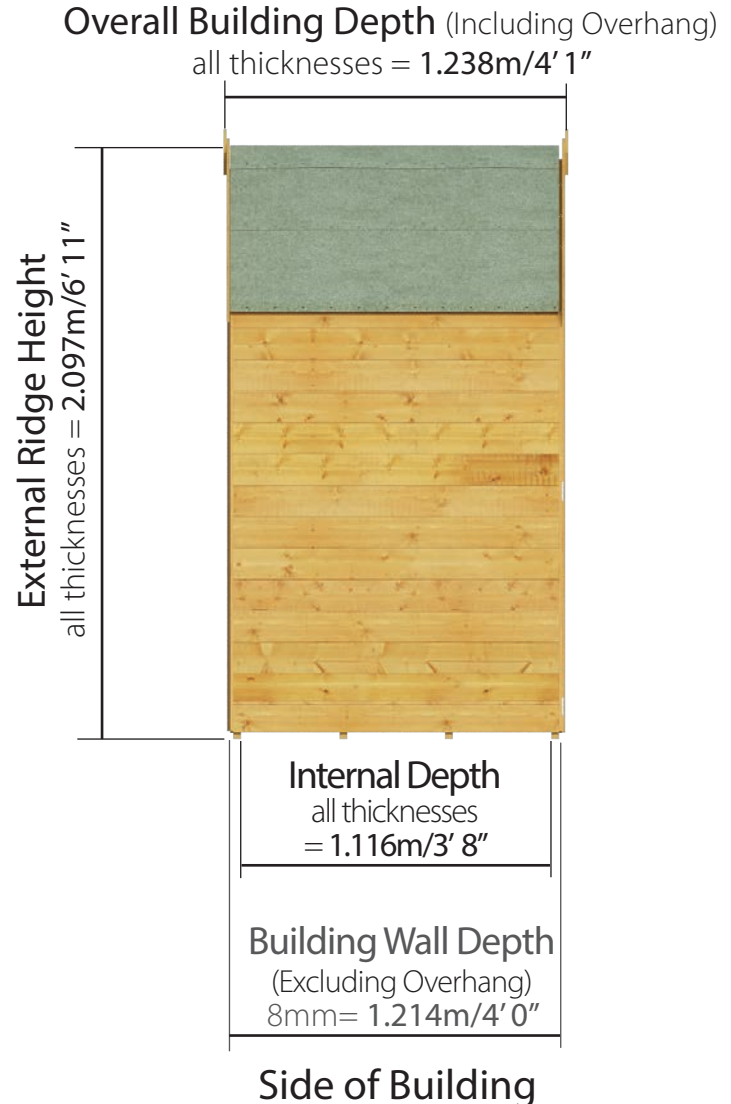

Floor Plan

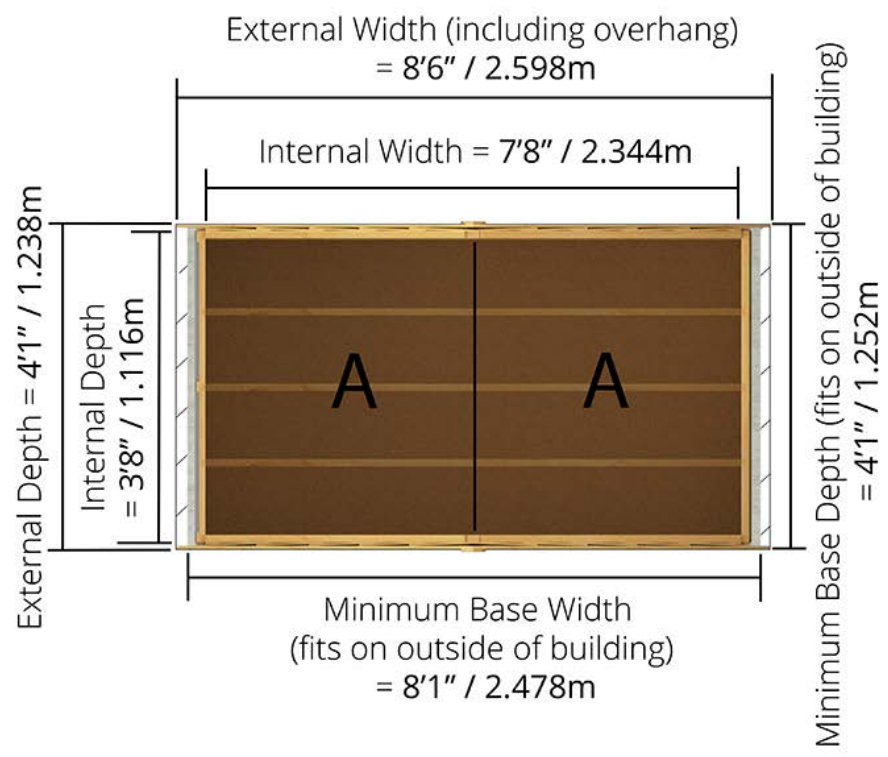

Floor Profile

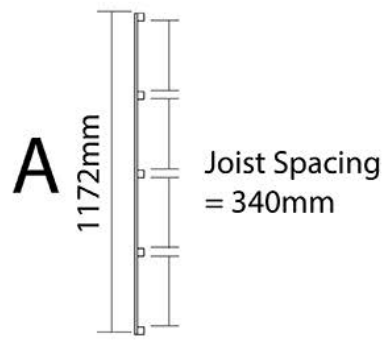

Please note: your base must be perfectly level and drainage is required to allow water to run off the surface. There must also be at least 2m clearance on each side to allow annual treatment to be applied.